

Configuring the VDS MCM-Scientific Atlanta Digital Interface

STEP 1: NETWORK CONFIGURATION

The first step in the configuration is to set up the appropriate TCP/IP settings. The Video Data Systems MCM Processor and Scientific Atlanta Application Server communicate using the TCP/IP protocol. To configure the TCP/IP settings go to the **Start Menu**, select **Settings** and then **Control Panel**. Once the window appears double click on **Network** and you will be presented with the network configuration dialog box. Highlight the entry in the list that binds the TCP/IP protocol to the installed network adapter and then click the **Properties** button.

Configure the TCP/IP properties in whatever fashion necessary to obtain communications between the two units. Below are the default settings:

IP Address: 12.0.0.96
Subnet Mask: 255.0.0.0

In most cases the default settings will not be appropriate for you network. If necessary please contact your network administrator. After you are done configuring the TCP/IP settings you might be directed to reboot the computer. Once the computer is back up and running proceed to the next step.

STEP 2: CONFIGURING THE MCM SOFTWARE

If this is the first time you are configuring the MCM Software the entry screen should be open on your desktop. Find the window that appears as pictured below:

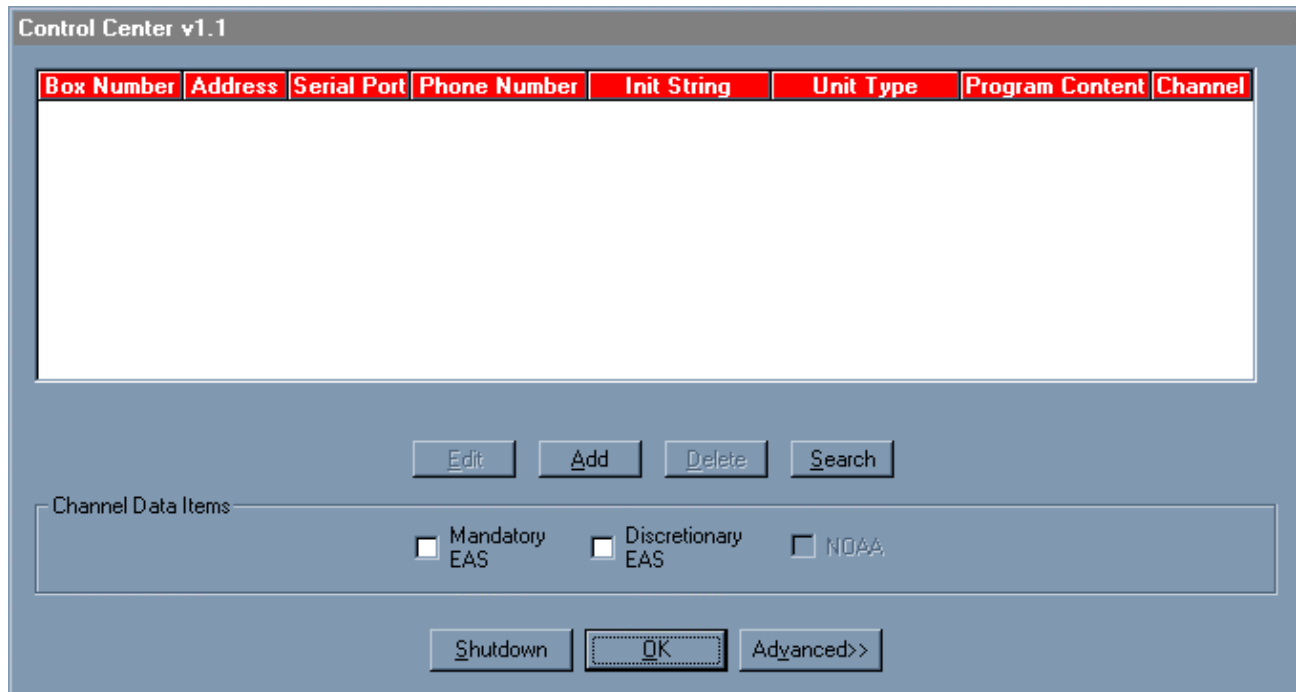

If this is not the first time you have configured the software, you can get to the screen above by looking at the tray area of you task bar. The tray area is the area of the task bar that usually contains the time display. It might look as pictured below:



SARMU/STARMU
OPERATOR'S MANUAL

Notice how there is a little icon that looks like a television set. Click on the icon and select **Configure**. You will then be at the main software screen as pictured above.

Now that you are at the main software screen, click on the **Advanced**>> button. Clicking on this button will take you to the entry screen that allows you to configure the SA interface. The screen appears as pictured below:

Advanced Settings

Please choose which data sources are available to your MCM System.

EAS Serial Port **NA**

Weather Serial Port **NA**

NOAA Serial Port **NA**

SA Serial Port **NA**

IP Address

Port

FTP Username

FTP Password

NOTE: Change these items with caution. If you are unsure as to the appropriate settings for your MCM System, please contact technical support.

OK Cancel

The only area that is relevant is the section on SA. To enable the SA interface click on the box next to the word **SA**. That will enable the other entry boxes in the section and it will appear as pictured below.

SA Serial Port **NA**

IP Address

Port

FTP Username

FTP Password

Now we must configure the 5 remaining items.

IP Address: This is the IP Address of your SA Application Server. Enter the IP Address in this field. If you are unsure about the IP Address please consult the SA Application Server Software or your network administrator.

SARMU/STARMU
OPERATOR'S MANUAL

Port: This is the TCP/IP port for MCM-SA communications. Enter **4098**, (unless SA has given you a different value).

Serial Port: This denotes the serial port on the MCM Processor that is connected to the SAGE ENDEC. Click on the down arrow and select **2** for **COM2**.

FTP Username: This is the username that the software uses to log into the SA Application Server's FTP Server. Enter **easftp**, (unless SA has given you a different FTP Username).

FTP Password: This is the password that the software uses to log into the SA Application Server's FTP Server. Enter **easftp**, (unless SA has given you a different FTP Password). When entering the password, each key-press will be represented by an asterisk.

Once the information has been entered the screen will appear as pictured below:

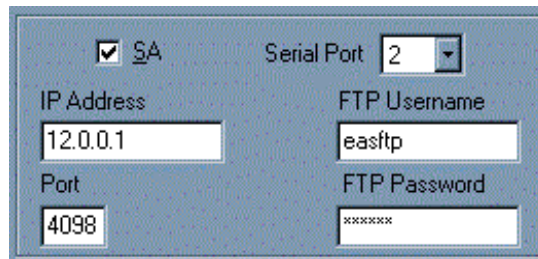

<input checked="" type="checkbox"/> SA	Serial Port	2
IP Address	FTP Username	easftp
12.0.0.1		
Port	FTP Password	*****
4098		

NOTE THAT THE IP ADDRESS FOR YOUR SYSTEM WILL BE DIFFERENT. Finally click the **OK** button to confirm the settings.

STEP 3 BEGIN THE MONITORING FOR EAS MESSAGES

Once you have entered all the information and clicked the **OK** button you will again be at the main screen. To begin monitoring for EAS messages, click the **OK** button on the main screen. The application will now minimize to the taskbar tray as a television set and will be run as a background process.

Overview

The MCM Control Center gives the user the flexibility to distribute EAS, NOAA, and Weather information to only those channels that will be displaying that type of information. In addition it also provides an interface between the SAGE EAS Endec and the Scientific Atlanta Digital EAS Controller. For example, you might choose to have channels 1,2, and 3 in a 30 channel system displaying discretionary EAS messages. The MCM Control Center can easily be configured to accomplish this. Also channels 4,5 and 6 might be the only ones in the system displaying NOAA information. Again this can easily be configured through the MCM Control Center Software.

The MCM Control Center is the heart of the MCM System. It is responsible for retrieving data from all the external sources and distributing it as necessary. Together with the PCS Software, the MCM Control Center allows a total programming solution for your cable systems multi-channel messaging system.

SARMU/STARMU
OPERATOR'S MANUAL

Data Sources

Below is a list of all the available data sources. If a data source is available its check box will be enabled when configuring a channel.

- EAS:** If there is a SAGE EAS Endec attached to your MCM Controller then the EAS data source is available. There are two types of EAS messages required and discretionary. Required alerts (EAN,EAT,RWT,RMT) must be shown on all channels as mandated by the FCC. All other alerts (discretionary alerts) are voluntary. It is up to the cable operator to choose whether or not to show the discretionary alerts on a particular channel. The MCM Control Center will distribute all required alerts to all channels. Each channel can be configured to show the discretionary alerts.
- Weather** If you have purchased the weather option with your MCM system, you were provided a RainWise Weather System. The MCM Control Center queries the RainWise package every minute for updated weather information.
- NOAA** If a NOAA receiver is available then an additional source of weather information is available.
- SA** The Scientific Atlanta Digital Interface is not available to distribute to the MCM channels and will not appear in the list of available data sources. The Interface is responsible for communicating EAS alerts through a TCP/IP network equipment supplied by Scientific Atlanta. These alerts will then trigger certain actions on the digital channels.

Definitions

- Box Number** : This is the number of the MCM box that contains the specific channel card. This number will be labeled on the back of the box.
- Address** : This is the address of the channel card. Each card will have a unique address on a specific serial port. Addresses can be duplicated as long as they are on different serial ports. There are several reserved addresses that should not be used by any channel card. These addresses include **1,8,17,19,60,127**. The addresses for all the channel cards in the system will be configured at the factory.
- Serial Port** : The serial port field denotes which port on the MCM Controller a particular MCM Box is attached to. The combination of box number, address, and serial port must be unique.
- Program Content:** This is for informational purposes only. For example if a particular channel was showing CNN that program content might be CNN.
- Channel** : The channel on the local cable system this channel card is handling.

Configuring the MCM Channels

NOTE: If you are using the MCM Controller ONLY to interface with the Scientific Atlanta Digital Set Top Boxes you do not need to do this step. Please skip to the Advanced Settings Section.

The MCM Control Center has been configured at the factory for all the channels in your MCM system. This includes adding each item to the list of channels, inputting all the vital statistics about the channel as well as configuring each channel for the default information mode. The default information mode is to show ALL EAS messages on all channels.

To view the configuration, notice that on a running MCM Controller there is a TV icon in the task bar. When you click on the TV icon, you will be presented with a menu as pictured below:



To view or change the channel configuration select the *Configuration* menu item. Note that when the MCM Control Center is in configuration mode, all information gathering will stop. In addition no EAS messages will be processed. The main configuration screen appears as pictured below:

A screenshot of the 'Control Center v1.3' configuration window. The window has a blue title bar and a table of channel configurations. Below the table are buttons for 'Edit', 'Add', 'Delete', and 'Search'. At the bottom, there is a section for 'Channel Data Items' with checkboxes for 'Mandatory EAS', 'Discretionary EAS', and 'NOAA'. At the very bottom are buttons for 'Shutdown', 'OK', and 'Advanced >>'.

Box Number	Address	Serial Port	Phone Number	Init String	Unit Type	Program Content	Chann
16	55	4			CG without Logo	A&E	B14
17	31	4			CG without Logo	CNBC	A45
17	32	4			CG without Logo	HGTV	A51
17	33	4			CG without Logo	Cartoon	A50
17	34	4			CG without Logo	HomeShop	B4
17	35	4			CG without Logo	BET	A56
17	36	4			CG without Logo	E!	A39
17	37	4			CG without Logo	PBS	A11
17	38	4			CG without Logo	FX	A13

Notice that each row in the list describes the characteristics of one channel. For example, look at the channel that is highlighted. The channel card is in MCM box 1, with an address of 32, on serial port 6. The program content is the SPICE channel that appears on the cable system on channel 68. Now look at the bottom of the MCM Control Center at the section that is labeled *Channel Data Items*. The highlighted channel has been configured to display discretionary EAS alerts, weather information, as well as NOAA information. If we wanted to configure the channel so it no longer displays NOAA information, all that is

SARMU/STARMU
OPERATOR'S MANUAL

required is to uncheck the box that is labeled *NOAA*. In that case the configuration screen would appear as pictured below:

Box Number	Address	Serial Port	Phone Number	Init String	Unit Type	Program Content	Chann
16	55	4			CG without Logo	A&E	B14
17	31	4			CG without Logo	CNBC	A45
17	32	4			CG without Logo	HGTV	A51
17	33	4			CG without Logo	Cartoon	A50
17	34	4			CG without Logo	HomeShop	B4
17	35	4			CG without Logo	BET	A56
17	36	4			CG without Logo	E!	A39
17	37	4			CG without Logo	PBS	A11
17	38	4			CG without Logo	FX	A13

Channel Data Items:

Mandatory EAS Discretionary EAS NOAA

Buttons: Edit, Add, Delete, Search, Shutdown, OK, Advanced >>

Notice that the *NOAA* check box is now unchecked. Similarly check or uncheck the discretionary EAS and weather as appropriate. That is all it takes to configure an MCM channel. Also take note that all the external data sources (EAS, Weather, NOAA) might not be available on your system. If a data source is not available the check box will be disabled and you will not be able to select it when configuring a channel.

When your MCM comes from the factory it will be configured with the number of channels that you have purchased. If you purchased 12 channels, each channel will appear in the list above. The Program Content Field and the Channel Field will be left blank however. These fields are for informational purposes only and do not have to be present for the MCM Control Center to operate properly.

Editing Channel Information

To edit the information associated with a channel (besides the data distribution) you must first be in the configuration mode as outlined above. Once in the configuration mode highlight the channel you want to modify. Now click the *Edit* button. The edit screen appears as pictured below.

The screenshot shows a dialog box titled "Edit Item" with a blue header. It is divided into three sections:

- Unit Information:** Contains two text boxes: "Box Number" with the value "17" and "Address (in decimal)" with the value "33". Below these are four radio buttons for "Unit Type": "Logostar", "Star-8", "CG with Logo Capability", and "CG without Logo Capability". The "CG without Logo Capability" option is selected.
- Connection Information:** Contains two radio buttons for "Serial" and "Modem". The "Serial" option is selected. To the right are three text boxes: "Serial Port" with the value "4", "Init String", and "Phone Number".
- Identification Information:** Contains two text boxes: "Program Content" with the value "Cartoon" and "Channel" with the value "A50".

At the bottom of the dialog box are two buttons: "OK" and "Cancel".

Notice how all the information from the main screen is now present in the edit screen. To edit any of the information simply click on the entry box and type in the new information. Remember that these items, not including the program content and channel, have been filled in at the factory. If you are not sure of the settings for box number, address, or serial port please contact technical support.

Once you have made the changes click on the *OK* button to accept the changes or click the *Cancel* button to cancel the edit. If you have changed the box number, address, or serial port and a channel already exists with that identical information you will be asked to re-enter the information. If the changes have been accepted, the modified channel information will now appear in the main configuration screen.

Adding New Channels

To add a new channel to the MCM Control Center you must first be in configuration mode as outline above. Once in configuration click the *Add* button. You will be presented with an entry screen as pictured below.

The screenshot shows a dialog box titled "Add Item" with a blue header. It is organized into three main sections:

- Unit Information:** Includes two text input fields labeled "Box Number" and "Address (in decimal)". Below these are four radio button options for "Unit Type": "Logostar", "Star-8", "CG with Logo Capability", and "CG without Logo Capability".
- Connection Information:** Features two radio buttons for "Serial" and "Modem". The "Serial" option is selected. To the right are three text input fields labeled "Serial Port", "Init String", and "Phone Number".
- Identification Information:** Contains two text input fields labeled "Program Content" and "Channel".

At the bottom of the dialog are two buttons: "OK" and "Cancel".

Now fill in all the information for the new channel. Be careful when filling out the box number, address, and serial port. If you are unsure about these settings please contact technical support. Also note that the program content and channel fields are optional and are only there to help you identify a particular channel card. The MCM Control Center and data distribution will function properly without this information.

Once you have entered all the information, click the *OK* button or *Cancel* to abort the addition. When the addition has been completed the new channel will appear in the list of channels on the main configuration screen.

Deleting Channels

To delete a channel from your MCM Control Center configuration, first you must enter configuration mode. Once you are in configuration mode, select the channel you would like to delete. You will be prompted to confirm the deletion. Click *Yes* to confirm or *No* to cancel.

SARMU/STARMU
OPERATOR'S MANUAL

Advanced Settings

To view or modify the advanced settings, enter into the configuration mode and click the *Advanced>>* button. You will then be presented with the following entry screen.

Advanced Settings

Please choose which data sources are available to your MCM System.

EAS Serial Port: 10

Weather Serial Port: 5

NOAA Serial Port: 7

SA Serial Port: 11

IP Address: 12.0.0.196 FTP Username: easftp

Port: 4098 FTP Password: xxxxxxxx

NOTE: Change these items with caution. If you are unsure as to the appropriate settings for your MCM System, please contact technical support.

OK Cancel

Note that there is a configuration item for all three data sources and the Scientific Atlanta interface. To activate any one of the four options first click the check box next to the item you want to enable. This will then enable the entry items related to that option. For example, let's say we want to activate the weather data source. We would first click on the weather check box and make sure it is checked. That would in turn enable the serial port selection box located to its right. Choose the appropriate serial port that is connected to the Rainwise Weather Station. To enable the EAS or NOAA data sources perform the same steps.

To enable the SA Interface first check the SA check box. Then choose the serial port that is connected to the SAGE Endec specifically for the SA Interface. Now notice how the other fields (ip address, port, username and password) are now enable. Fill in those fields as appropriate.

Once you are done, click the *OK* button to confirm the modifications or click the *Cancel* button to abort the changes.

Please Note that these settings (except the SA Interface) has been setup at the factory. Only change these items if you are sure about the changes. If you have any questions, please contact technical support.

SAGE EAS Endec Settings

When you are using an EAS data source or the Scientific Atlanta Interface you must properly configure the Endec.

- EAS** : The EAS data source must connect to one of the ENDEC's 9600 baud serial ports.
The serial port must be setup as a **VDS-MC** device
- SA** : The SA Interface requires the use of one of the ENDEC's 9600 baud serial ports.
The serial port must be setup as a **VDS-MCSA** device.

You have been supplied with a cable that has a mini phone plug on one end and two bare wire ends on the other end. The mini phone plug must be connected to the line in connector of the MCM Controller audio card. Connect the black wire (bare end) to a audio common terminal at the back of the endec. Connect the other wire to the Speaker Line out terminal.

In addition, for the FCC required Alerts (alerts that must go to all channels) which include the Emergency Action Notification, Emergency Action Termination, Required Weekly Test, and Required Monthly Test, you must not change the default alert text for those messages. The MCM Control Center looks for the default strings to know that it is a required message and that it must go to all channels. For example, the text for the Required Monthly Test, must contain the default text "Required Monthly Test" in order to be sent to all channels. Similarly the Emergency Action Notification text must contain the text "Emergency Action Notification" in order to be sent to all the channels. Usually these items are left to their default values. If you have any questions regarding this please contact technical support.

Configuration File

All the channel settings as well as the data source settings are kept in a file (mcm96.ini) in the windows directory. Do not modify this file yourself. The MCM Control Center will do it for you when you change any settings in the configuration mode.

Sections

[eas]

the serial port number on the mcm controller that is attached to the SAGE Endec that has been configured as a VDS-MC device and is running at 9600 baud
mcmport=10

[weather]

the serial port number on the mcm controller that is attached to the RainWise weather station
port=5

[noaa]

;the serial port number on the mcm controller that is attached to the NOAA Receiver
port=7

[addresses]

the content of each channel card string is

<box number><address in hex><port><eas><weather><noaa>
<prog content><channel>

<box number> this is for user information only..this is labeled on each mcm

<address> the address of the card in a particular mcm. Used in conjunction with the port value. This is a two character hex string. For example if the address is 20 in hex the string would contain the

SARMU/STARMU OPERATOR'S MANUAL

character two and the character 0
<port> combined with the <address> tag this uniquely identifies a particular card....This is just the serial port of where the mcm that contains the card is located.
<eas> if eas is enabled use 1 or else 0
<weather> if weather is enabled use 1 or else 0
<noaa> if noaa is enabled use 1 or else 0
<prog content> this is for user info only and will help them identify problems etc.
<channel> again this is for user information only and is not necessary.

0=1 20 6 1 1 0 SPICE 68
1=1 21 6 0 0 0 CINE a1
2=1 22 6 0 0 0 DISN A31
3=1 23 6 0 0 0 AMC A32
4=1 24 6 0 0 0 NBC a2
5=1 25 6 0 0 0 CBS a3
6=1 26 6 0 0 0 FOX a4
7=1 27 6 0 0 0 CNN a5
8=1 28 6 0 0 0 TBS a6
9=1 29 6 0 0 0 CNN1 a51
11=1 2a 6 0 0 0 VAG1 a31

[sa]

this is the ip address of the SA Application Server on the TCP/IP Network

ip=12.0.0.196

this is the port that the SA Application Server is accepting connections on

tcpport=4098

this is the username to use when logging into the ftp server located on the SA Application Server

ftp_user=easftp

this is the password to use when logging into the ftp server located on the SA Application Server

ftp_pass=easftp

this is the serial port on the mcm controller that is attached to the SAGE Endec that has been configured as a VDS-MCSA device and is running at 9600 baud.

port=11

Log File

An extensive log file (log.txt) is maintained in the main MCM Control Center directory (usually c:\mcm96). The log file contains all EAS alert notifications as well a log of any data that was retrieved from the weather station or NOAA receiver. Additionally it also logs each step in the SA Interface process.

The log file is automatically purged after 2000 lines. There is no need to maintain this file yourself. The log file is a plain ASCII Text document that can be viewed in any text editor such as Notepad, or Microsoft Edit.

SARMU Overview

The "SUB-ALERT" SARMU is a multifunction Processor/Controller specifically designed to accept EAS commands directly from the SAGE "ENDEC". Typically it is deployed to deliver digital EAS information, via Ethernet and TCPIP protocol, to either Scientific Atlanta or Pioneer Digital EAS Servers.

In addition, when the SARMU is deployed in combination with either the EAS/STAR-8 or MCM crawl systems, it can be used for a variety of multi-channel messaging requirements including, PPV Overlays,

SARMU/STARMU OPERATOR'S MANUAL

Cross-Channel Promotions, Syndex announcements or local messaging. The SARMU can individually control up to 192 channels.

Standard with every SARMU is our PCS window software, internal modem and PC Anywhere that allows any authorized user to access each of the 192 channels for text editing from a local keyboard or a remote PC.

Specifications

Software

SA Digital Interface
Windows 95 License
Control Center Software for MCM & STAR-8
PC Anywhere
VDS PCS Windows for remote text creation and editing

SARMU Processor Hardware

19" Rackmount chassis, Mother board and Power Supply w/ Keylock
Intel Pentium II processor
3.5 Disk Drive
32 Meg SDRAM
4.3 Gig Hard Drive (min.)
Modem (33600kbs) min.
VGA Card
VGA Monitor (13")
Ethernet Network Card
8 Port RS232 Expander Card
PS-2 Keyboard
Mouse

INPUTS

ENDEC	RS-232
Weather	RS-232
NOAA	RS-232
SA Audio	Baseband
Modem	Phone line (RJ45)

OUTPUTS

EAS DIGITAL	Ethernet RJ45 (100 Base T) TCP/IP Protocol
-------------	--

Weight	50 lbs.
Dimensions	19" wide x 4RU (7") tall x 20" deep

Scientific Atlanta™ Remote Monitoring Unit Interconnection Quick Start

SARMU By Keywest Technology™

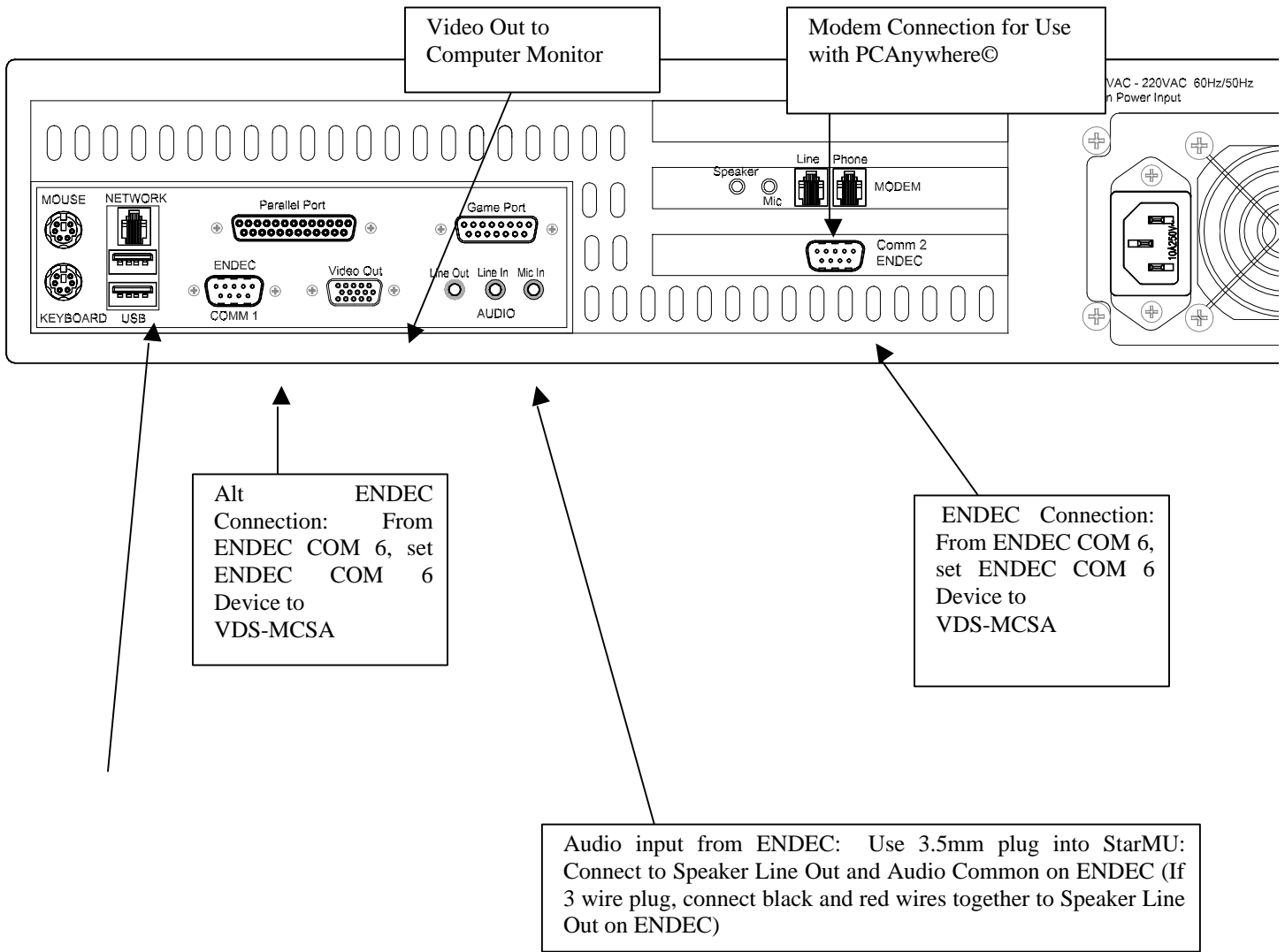

Note that the ENDEC connects to the StarMU with a supplied Null Modem Cable only. Other cables will not make proper link. ENDEC can connect to either Comm 1 or Comm 2. The default factory setting is Comm 1 to connect to ENDEC COM 3 (Analog for Star-8 Channels), and Comm 2 to connect to ENDEC COM 3 (Digital for Star-8 Channels) (App Server System)

SARMU

Installation of the STAR-8 character generator.

The STAR-8 has the capability of adding EAS character video to 8 video channels and switching 8 audio channels between their normal audio signal and the EAS supplied audio.

Installation instructions:

The unit required 1 rack unit of space.

All connections to the STAR-8 are from the rear panel.

Video connections are made using BNC connectors.

Connect the video in connectors for each channel to the appropriate video source.
Connect the video out connectors for each channel to the appropriate modulator.

The control line contact closure comes from the Sage ENDEC unit and is connected to the IN-G and IN-CT terminals on the STAR-8. You can connect additional STAR-8 units to the buffered relay contact closure of a STAR-8 by connecting the OUT-CT and OUT-CT lines to the IN-G and IN-CT terminals of successive units.

SARMU INSTALLATION

The SARMU connects a Sage ENDEC emergency alert system and other input sources to a Scientific Atlanta or Pioneer Digital EAS Server and to various combinations of character Video Data Systems character generator products. Upon commands from the ENDEC the SARMU will insert EAS emergency messages as a crawl overlay keyed into the incoming video signal and provide TCP/IP formatted information over an Ethernet connection to digital EAS server.

Base band audio is made available to the analog channels associated with the system by using the ENDEC contact closure output

When the ENDEC provides data to the SARMU the audio supplied from the ENDEC is digitized and presented to the digital EAS server as TCP/IP data over the Ethernet connection.

The other input sources accommodated by the SARMU are:

- 1) NOAA weather wire
- 2) locally installed weather instrumentation (Temperature, Barometer etc)
- 3) Remote (via modem) textual and control entry for the analog character generators.

For rack mounting there must be a 4 rack unit space available in the equipment rack.

The SARMU is powered from a 115v AC outlet.

DATA INPUT/OUTPUT

All serial ports, except the modem, are typically configured for 9600 baud data transmission.

The following data sources can be connected to the ports indicated:

- COM2:** Sage ENDEC SA data input
 - COM3:** Sage ENDEC normal analog EAS data input
 - COM4:** to MCM or STAR-8 analog channels
 - COM5:** to MCM or STAR-8 analog channels
 - COM6:** to MCM or STAR-8 analog channels
 - COM7:** to MCM or STAR-8 analog channels
 - COM10:** NOAA weather wire service
 - COM11:** local weather instrument package

 - RJ11:** for COM1, telephone line for the internal modem
 - RJ45:** This connector is used for the 10/100 BASE T network to digital EAS server
- EIGHT FEATURES OF THE STAR-8 DISPLAY SYSTEM**

Eight character generator channels are packaged in a standard one rack unit package.



Input to the unit is by means of a serial data line directly connected to a Sage ENDEC EAS decoder. A second serial port on the STAR-8 then allows one STAR-8 unit to be connected to on or more STAR-8s. *Thus any number of channels can be controlled by a single ENDEC device.* In this configuration each channel will receive and display the EAS message(s) from the ENDEC. All channels will

SARMU/STARMU
OPERATOR'S MANUAL

always display the same data.

One of the serial input lines to the STAR-8 can be connected to a control computer which pre-processes the ENDEC data and can then provide additional display and control capabilities for the STAR-8.

When managed by the computer each channel in the system has a unique address and therefore the data on each channel can be different. Each channel can display a single page of fixed information. The remote computer will manage and prioritize the ENDEC message. Software for this option will be available in 4Q 2000. Individual channels in any Star-8 are addressable and can be configured for which services they respond to, e.g. EAS mandatory, EAS discretionary, NOAA.

Even in an ENDEC only configuration each channels crawl position and speed can be set differently. This configuration must be performed by temporarily connecting a terminal, or PC running a terminal emulator, to the STAR-8 and supplying the proper information. Once configured the Star-8 units retain their configuration code in non-volatile memory.

Each channel of the STAR-8 operates as a down stream keyer using the video input (BNC connector) supplied. Input video is terminated internally in 75 ohms when relay is not in the bypass mode.

Video characteristics:

Diff phase < 0.5 degree

Diff gain < 0.5 percent

Freq response +/-0.5db

Video gain (output/input) = 1 (internal adjustment at factory)

Back porch is clamped to 0 vdc.

75 ohm source terminated video output on BNC connector.

Power fail safe relay bypass of video input to video output. When a control computer is provided, this relay can be controlled via the RS232 input port.

Gen lock to any standard NTSC source, including VHS

Font: 12x18 dot matrix. Characters are a fixed height of 36 scan lines. The character set contains 62 alpha numeric characters, and a limited set of punctuation symbols. Characters are always white with a black border.

The maximum capability of the display is 11 rows (including crawl) of 28 characters.

The memory of the STAR-8 is battery protected in the event of a power failure. Crawl message memory is 1000 characters per channel.

The EAS crawl message may be positioned anywhere on the screen (4 scan line position resolution). One of three crawl speeds available can be specified. Position and speed can only be changed from the computer interface port.

SARMU/STARMU
OPERATOR'S MANUAL

Audio:

A card can be installed (at the factory) in each STAR-8 chassis, to provide balanced **stereo base band** audio with relay controlled switching. Screw terminal connectors are available at the rear panel for audio connection. Relays are in the by-pass (non EAS) mode when power fails. Each STAR-8 unit contains a stereo audio distribution amplifier so that each stereo channel of the STAR-8 presents a single high impedance load to the audio source.

The audio relays can be controlled in two ways:

1) *When an EAS contact closure* control signal is supplied, all relays will switch over to the externally supplied EAS audio source. The contact closure supplied to the STAR-8 chassis for EAS switch-over is relay buffered to provide an isolated dry contact output (both NO and NC). In this way additional STAR-8 chassis may be daisy chained without overloading the ENDEC control relay.

2) If a control computer is connected to the STAR-8 then in addition to the input contact closure (always active) each channel's audio switch over may be controlled by software permitting selected channels to perform the EAS audio switch as command be the control computer.

Data input: DB9P connector for connection to data source, either ENDEC or master STAR-8, DB9P connector for connection to slave unit(s).

Package: Each 8 channel system is supplied in a standard 19" rack mount chassis, and occupies 1RU (1.75" high). Power is 115VAC 60Hz, standard IEC power cord, approximately 25 watts for each 8 channel unit.

All specifications subject to change without notice.
\\star8.doc

STAR-8 FUNCTIONS

October 11, 1999

The Star-8 is a low cost 8 channel analog character insertion system. It is capable of either displaying a single fixed page of information or crawling a single message for each of it's 8 channels. It can not display fixed information and crawl at the same time. The length of the crawl message is limited by practical constraints. The page message is limited to (characters) by (rows). Upon power failure the hardware automatically connects the video input directly to the video output, bypassing the unit. After a power failure the unit is to come up on a reset state with no characters on the display.

The following is a subset of CG8x0, MCM commands for Star-8. Note that some commands are not used by the Star-8 but are normally used by an ENDEC when directly connected. The Star-8 should not act upon any @ commands other than the ones indicated. For further command details see MCMProg.PDF.

There must be a hardware configuration jumper plug used to determine whether a Star-8 is connected directly to an ENDEC or is connected to a host processor

The Star-8 will acknowledge all @ commands with the standard return sequence of <CR><LF>V<CR><LF> if it is a valid command. All invalid commands will return the error sequence of <CR><LF>EB<CR><LF>

When configured for direct connection to an ENDEC the Star-8 unconditionally processes the following commands:

SARMU/STARMU
OPERATOR'S MANUAL

@begin,nn; is the code to start an EAS page. This is what is sent directly from the ENDEC in a non processor configuration. The value of nn is irrelevant.

@bkcolor,nn; where nn is from 1 to 16. specifies a background color band for the EAS crawl line. Note that Star8 does not know about color, but, is it possible to use the gray band capability of the ST5730????

@end; will terminate any message started with @begin

@eastimes,pp,ss,nn; This command causes the message number pp to begin crawling starting at scan line ss (relative to a field) for nn times. Since the ST5730 can not position to absolute scan line, the Star-8 will resolve this to the nearest line that the ST5730 text row configuration will allow. When this command is input from an ENDEC on the RS232 port the value of pp will always be 99.

When connected to a processor the Star-8 processes the following commands in addition to those listed above.

SOH <address> select a particular channel to receive data. A jumper block in the Star-8 determines the base address of the 8 channels in the box. All channels are then referenced to this base address. The base address can be set to any 7 bit number. Certain channel address numbers are not useful. See discussion in MCMProg.PDF relating to channel addressing so that the Star-8 addresses are compatible with the MCM address scheme.

@easnop; clears all control bits for the addressed channel that can be set with @easm; @easd; @noaap;

@easd; will tell the addressed channel that it is to accept eas discretionary messages that are sent with the command @begin,253; as well as mandatory message @begin,252.

@easm; will tell the addressed channel that it is to accept eas mandatory messages that are sent with the command @begin,252;

@noaap; will tell the addressed channel that it is to accept noaa messages that are sent with @begin,250; or @begin,251;

@begin,250; In a normal 8x0 CG this command will be translated into @begin,94; only if the command @noaap; has been issued. In Star-8 units this command is for the first of two possible noaa messages.

@begin,251; In a normal 8x0 CG this command will be translated into @begin,95; only if the command @noaap; has been issued. In Star-8 units this command is for the second of two possible noaa messages.

@begin,252; In a normal 8x0 CG this command will be translated into @begin,99; only if the @EASM; or @EASD has been issued (this is the mandatory eas message) In a Star-8 unit this command is an eas message

SARMU/STARMU
OPERATOR'S MANUAL

@begin,253; In a normal 8x0 CG this command will be translated into @begin,99; only if the @EASD; has been issued (this is the discretionary eas message). In a Star-8 unit this command is an eas message.

@endnoaa; will terminate any message started with @begin and will start that message crawling until another message is received. This command is only applicable if the command @noap;

@eastimes,pp,ss,nn; In the case of Star-8 connected to a processor this command is recognized only if either @easm; or @easd has been previously issued and a valid eas message has been received. The message number pp must be the page number for which eas message is to be run, either 252 or 253. In any case, the number is used to check permission level only. Both messages get stored in the same memory location in the unit.

The Star-8 will not respond to this command if pp is 99 in a processor configured unit.

@fast; set the crawl speed to fastest

@med; set the crawl speed between fastest and slowest

@slow; set the crawl speed to slowest

@crawl position,ss; set the crawl position to scan line ss (relative to a field). Use this command to set crawl position for a noaa message. See @eastimes; for use of ss.

@page,nn; If you sent data to the system and that data has embedded LF codes, then this command will display that data as a page. This page can have one or more rows of text. The number nn is not relevant. The last page sent to the Star-8 will be displayed.

@show,nn,tt; This command will cause the last message sent to the channel to crawl for tt times at the last specified speed and the last specified crawl position.

@key on; This command will enable the keying of characters into the incoming video display.

@key off; This command will disable the keying of characters into the incoming video signal.

@hello; The unit will respond with a channel address and the single character 4 for each of the eight channels.

@version; The unit will respond with:

```
<CR><LF>STAR8 Copyright Video Data Systems (c)VDS 10/06/99<CR><LF>
```

where the date shown above is replaced with the current firmware release date.

@set clock,yy,mo,dt,dy,hh,mm,ss;

See discussion in MCMPROG.PDF for details.

@time; This command will retrieve the current time known by the clock chip.

@get uni; This command will retrieve the configuration previously set with the @easd, @easm and @noap; commands above. It will return a single character: Refer to MCMPROG.PDF for details.

SPECIAL CHARACTER PROCESSING:

The Star-8 will process all ASCII characters in the range of 0x20 thru 0x7f as text characters. A complete list of all characters supported by the PCS software is available in MCMPROG.PDF. Characters not specifically processed by the PCS do not have to be processed by the Star-8. The degree character processed by the CG8x0 units does not have to be processed by the Star-8.

There are certain character sequences that must be handled specially in order to maintain compatibility with the PCS software that communicates to MCM channels. The PCS software supplies 5byte attribute packets to define various functions relating to font, color etc. These packets are fully described in MCMPROG.PDF in the section on Alternate Text Attribute Data Entry Format. They consist of the following sequence ~xxx~ (0x7e<char><char><char>0x7e). These packets are to be ignored by the Star-8.

The following tokens are to be recognized by the Star-8. Refer to MCMPROG.PDF for details about token processing. Note that token use is case sensitive.

%h display the current hour of the real time clock (show_hour,0x48)
%m display the current minute of the real time clock. (show_min,0x4d)
%s display the current second of the real time clock. (show_sec,0x53)
%l display the current month of the real time clock. (show_clock_month,0x4c)
%w display the current day of week of the real time clock as three characters, MON TUE etc. (show_clock_day,0x57)
%x display the 2 least significant digits of the year of the real time clock. (show_short_year,0x58)
%y display the complete 4 digit year, e.g. 1998, 2001 etc. Note that Video Data Systems products in this family are year 2000 compliant
%d display the current date of the month.

all other tokens are to be ignored and printed as plain text.

Star-8 configurations

There are two serial ports on the Star-8. Com 1 can be configured for both RS422 and RS232. Com2 is only RS232.

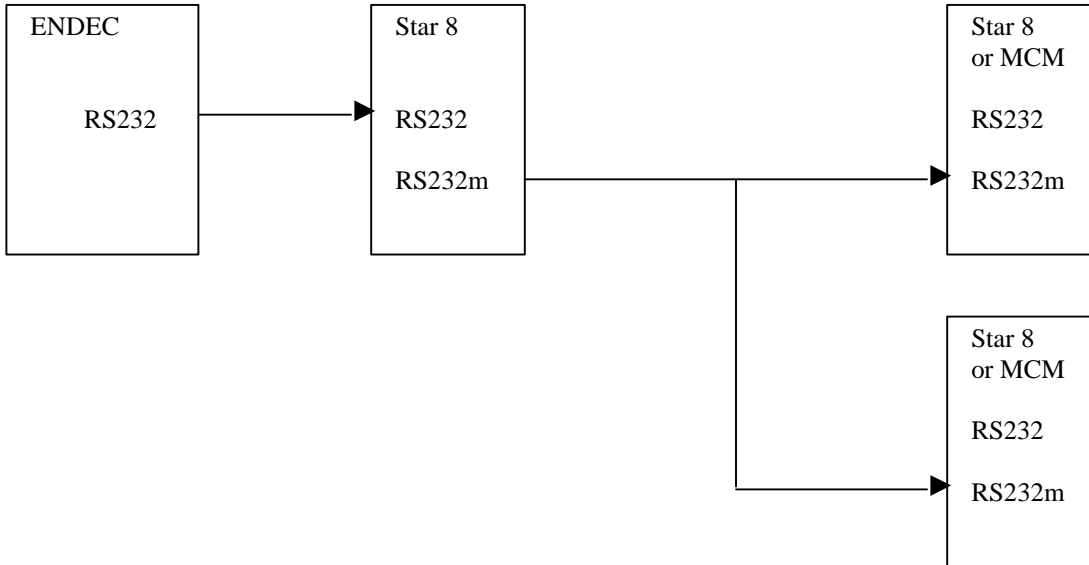

The RS232m port shown is a modification to the standard RS232 port that permits placing of the transmitter (out of the Star-8) into a tri-state mode. This permits selection of which channel is to be capable of sending data out. All channels are always in receive mode. Refer to addressing considerations discussion above and in MCMPROG.PDF.

Basic Star-8 configuration has the Sage ENDEC connected to the RS232 input to a Star-8. Additional Star-8 units are connected to the RS232m output port of the first Star-8 and will receive their EAS data from the first Star-8. Individual channels in any Star-8 are addressable and can be configured for which services they respond to, e.g. EAS mandatory, EAS discretionary, NOAA, as well as their crawl position and speed. This configuration must be performed by temporarily connecting a PC or terminal to the RS232m bus and supplying the proper information. Once configured the Star-8 units retain their configuration code in non-volatile memory.

In the case of an ENDEC as being the only data source, standard MCM192 boxes can be added to the RS232m port bus. The MCM192 and Star-8 use the same configuration for this port. The constraints of the addresses available as defined in MCMPROG.PDF apply to all boxes in the chain. The MCM units will get their EAS data from the first Star-8 unit. Note that it is a hardware constraint that all 8 channels in a Star-8 be monotonically consecutive, but channels in an MCM box can be random.

It is possible to remove the ENDEC connection to the RS232 port and replace it with a connection from a control computer to the RS232m bus. In this configuration the control computer will process the ENDEC and other data sources, such as NOAA, weather instruments, DTMF control signals, etc. and will communicate via direct wire or modem connection to the RS232m bus (not the RS232 bus)

STAR-8 USER'S GUIDE

Installation and Connections

The STAR-8 connects up to 8 video/stereo audio channels to a Sage ENDEC emergency alert system. Upon commands from the ENDEC the STAR-8 will insert EAS emergency messages as a crawl overlay keyed into the incoming video signal. When the ENDEC provides a contact closure to the STAR-8 the audio supplied from the ENDEC is connected to all channel's audio output

For rack mounting there must be a 1 rack unit space available in the equipment rack.

The STAR-8 is powered from a 115v AC outlet.

VIDEO CONNECTIONS

All video connections are made using BNC connectors. There are 16 BNC connectors on the rear panel of the STAR-8. Each connector is labeled as Video IN and Video OUT for a specific channel. Note that in the absence of power, the internal relays are not energized and a connection is provided between the Video IN and Video OUT for each channel. When the relay is energized the input video is terminated in 75 ohms. The output video signal back porch is clamped to zero and is source terminated and capable of driving a single 75 ohm terminated cable.

CONTROL CONNECTIONS

There is a single 4 terminal connector block for connecting the contact closure from the Sage ENDEC to the STAR-8. The STAR-8 provides a set of buffered contacts which follow the input contact closure. In this way additional STAR-8 units can be connected in series so that the contact closure of the Sage ENDEC is not overloaded.

The contact closure is applied to the 4 pin connector labeled:

Label	Function
CONTACT-G	from ENDEC or previous STAR-8
CONTACT-CT	from ENDEC or previous STAR-8
CONTACT-C0	to next STAR-8
CONTACT-C1	to next STAR-8

You connect the first STAR-8 to the pair of wires on the ENDEC labeled "Decoder Active" You connect the G and CT control input terminals of the second STAR-8 unit to the C0/C1 terminals of the first star 8 , etc. It does not matter which ENDEC wire is connected to the G or CT terminals, nor does it matter which wire of the C0/C1 pair connects to the second IN-G or IN-CT terminal.

DATA INPUT

The data source for the STAR-8 comes from the Sage ENDEC. A serial data cable is provided which will connect the port labeled SERIAL 2 to the port configured on the ENDEC as data output, typically COM2.

Signal for STAR-8	ENDEC pin (DB9S)	STAR-8 pin (DB9S)
RxD data input	3	2
TxD data output	2	3
Ground	5	5

It is possible to connect multiple STAR-8 units as slave units to the single STAR-8 that receives data from the ENDEC. To do this, you would connect the SERIAL- 1 port on the STAR-8 to the SERIAL 1 port on the additional units. In this configuration the first STAR-8 will transmit all input ENDEC serial data to the additional units.. Your SERIAL 1 port is factory configured as RS 422. The cable connections are as follows:

Master		Slave(s)	
transmit +	6	receive +	8
transmit -	7	receive -	9
receive +	8	transmit +	6
receive -	9	transmit -	7
ground	5	ground	5

When using this wiring configuration you must place a 120 ohm 1/8 watt resistor at the last slave connector across pins 8 and 9. You must also place a 120 ohm 1/8 watt resistor at the Master connector across pins 8 and 9. You may connect all slave units together by means of a daisy chained ribbon cable. The connector to the Master unit will have to be hard wired to effect the crossover connections.

SARMU/STARMU
OPERATOR'S MANUAL

The maximum number of slave units that can be connected is 30.

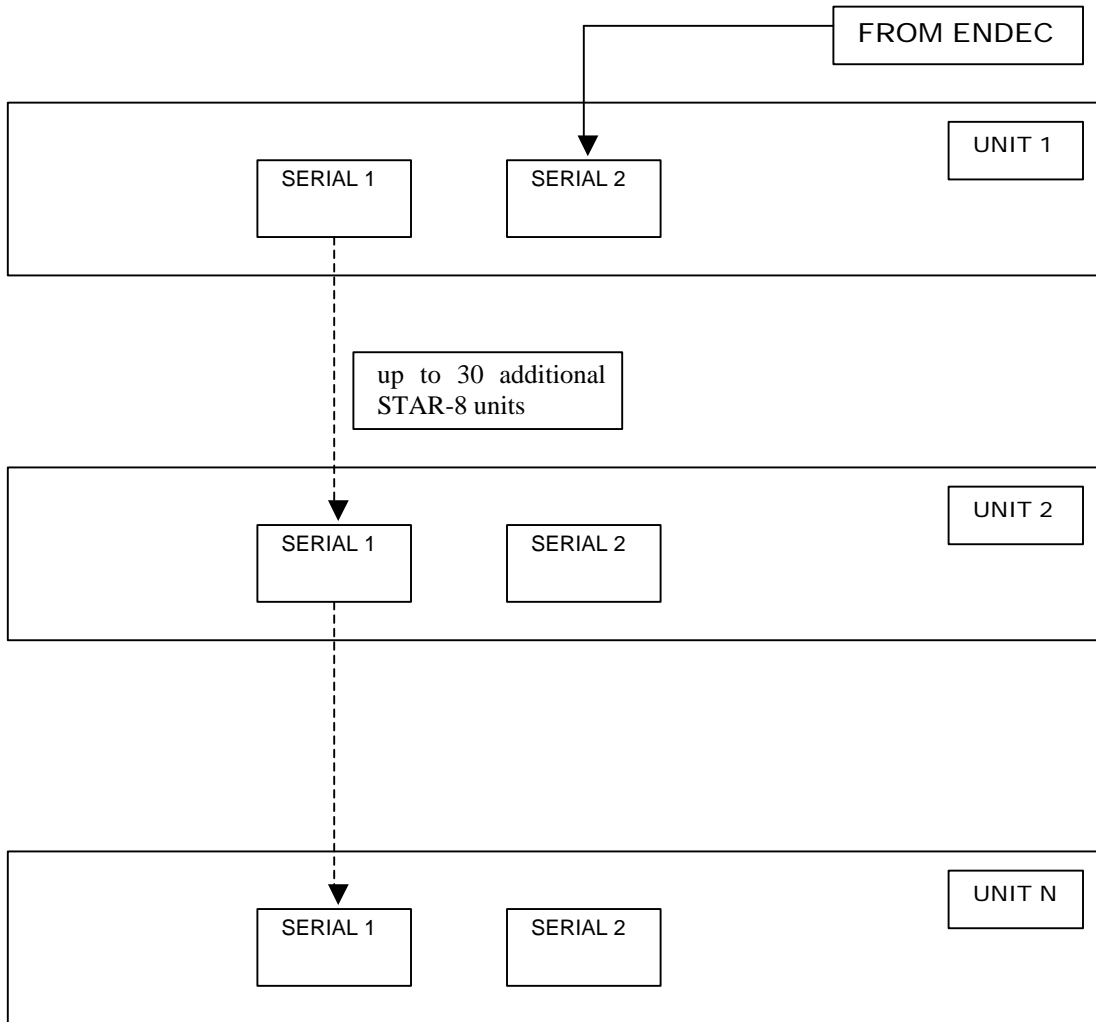

SARMU/STARMU
OPERATOR'S MANUAL

When making ribbon cables to interconnect multiple STAR-8 units you can make one daisy chain cable for ALL units including the master. Use DB9-S connectors on the ribbon connector. If the master unit is at the end of the chain, then install two extra DB9-S connectors, one at each end of the ribbon. Then make up a standard DB9-P connector with a 120 ohm resistor between pins 8 and 9. That connector will be installed at the unused DB9-P of the ribbon at the end of the chain. Make up a null modem type cable with standard solder type DB9-P connectors on both ends. In this cable connect the wires as shown below crossing the transmit and receive pairs. Also, install a 120 ohm resistor between pins 8 and 9 of the connector that will be connected to the Master unit.

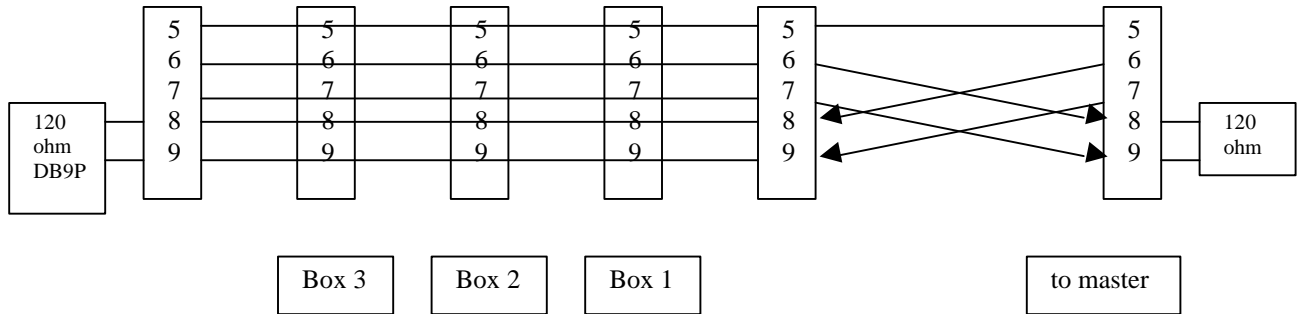

If you must connect the master unit somewhere in the middle of the chain, then you should use the null modem type cable described above between the cable position designated for the master and the master unit. Note that when you provide the master at a mid point connection then you should provide two terminating DB9P connectors, one at each end of the ribbon cable, each one with a 240 ohm termination resistor across pins 8 and 9.

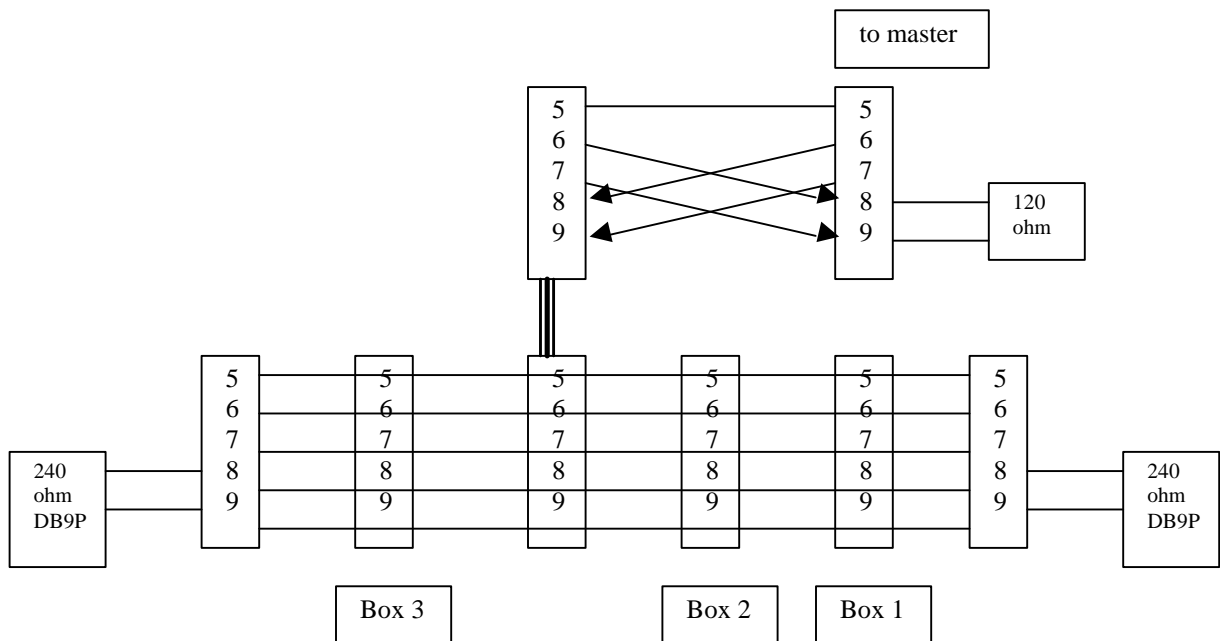

Above diagrams show connection of 4 STAR-8 boxes for a total of 32 channels.

SARMU/STARMU
OPERATOR'S MANUAL

AUDIO CONNECTIONS

All audio connections are made by means of screw terminals on the rear of the STAR-8. There is a single 5 terminal connector block for connecting a source of (balanced) stereo audio to the STAR-8. Audio input is applied to a high input impedance (>20k ohms) distribution amplifier so that each of the 8 output channels is driven independently. There are four 18 terminal connector blocks for connecting the balanced stereo audio input and output leads for each of the 8 channels.

Audio connections are made from the ENDEC "Speaker Line Out" and "Audio Common" terminals (which is unbalanced) to the STAR-8 audio input for the left channel. Currently the right channel is unused for EAS. You should use shielded twisted pair wire for all audio connections. In all cases the shield wire goes to a ground terminal. Make sure you note the polarity of the balanced signal. When connecting an unbalanced input, such as from the ENDEC, to the STAR-8 always connect the audio signal lead to the STAR-8 + (plus) input terminal and ground the - (minus) input terminal. When connecting a balanced output of the STAR-8 to an unbalanced load do NOT connect the - (minus) output, use the +(plus) output and ground. Each output amplifier is capable of driving a single 600 ohm balanced load.

You should supply a 600 ohm (standard value is 620 ohms) resistor to terminate the audio input line to the STAR-8. Terminations should be supplied as needed from the STAR-8 outputs to your final audio output.

Connections for the audio channels:

Channels 1,3,5,7		
Signal	IN	OUT
L+	13	11
L-	12	10
R+	18	16
R-	17	15
GND	14	

Channels 2,4,6,8		
Signal	IN	OUT
L+	4	2
L-	3	1
R+	9	7
R-	8	6
GND	5	

star8install.doc

SARMU/STARMU
OPERATOR'S MANUAL

It is possible to connect multiple STAR-8 or MCM units to a single serial communications port of the SARMU. To do this, refer to the connection manual for the STAR-8 and MCM character generators.

AUDIO CONNECTIONS

Audio connections are made from the ENDEC "Speaker Line Out" and "Audio Common" terminals (which is unbalanced) to the STAR-8, MCM and SARMU audio inputs for the left channel. Currently the right channel is unused for EAS. You should use shielded twisted pair wire for all audio connections. In all cases the shield wire goes to a ground terminal.

The audio connector from the ENDEC unit is wired first to the MCM or STAR-8 units. Each of these units presents a high-impedance load. At the last connection of an MCM or STAR-8 a connection can be made to the line input of the SARMU processor. The audio line will then be terminated by the internal termination of the SARMU audio processor card. Since we use the left audio channel for all EAS audio, wire the ENDEC audio out to the tip and sleeve connections of the 1/8 inch stereo input connector to the SARMU. For STAR-8 and MCM connections refer to the connection manual for the STAR-8 and MCM character generators.

//SARMUinstall.doc

Installation of the STAR-8 character generator.

The STAR-8 has the capability of adding EAS character video to 8 video channels and switching 8 audio channels between their normal audio signal and the EAS supplied audio.

Installation instructions:

The unit required 1 rack unit of space.

All connections to the STAR-8 are from the rear panel.

Video connections are made using BNC connectors.

Connect the video in connectors for each channel to the appropriate video source.
Connect the video out connectors for each channel to the appropriate modulator.

The control line contact closure comes from the Sage ENDEC unit and is connected to the IN-G and IN-CT terminals on the STAR-8. You can connect additional STAR-8 units to the buffered relay contact closure of a STAR-8 by connecting the OUT-CT and OUT-CT lines to the IN-G and IN-CT terminals of successive units.

Star 8s are addressed using Hexadecimal Numbers on the header labeled JP6.

SARMU/STARMU
OPERATOR'S MANUAL

STAR 8 ADDRESSING

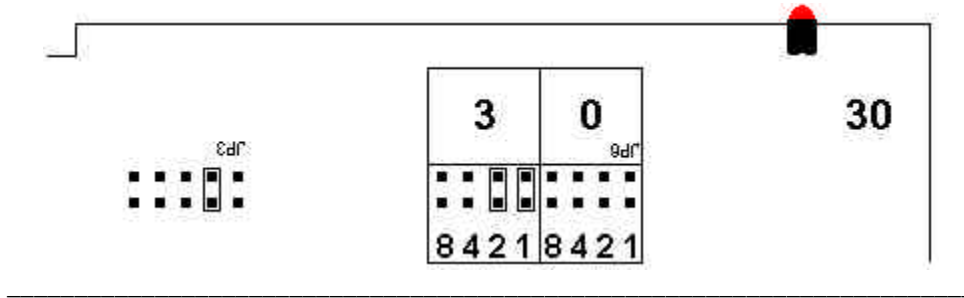

A1 - B1 - C1

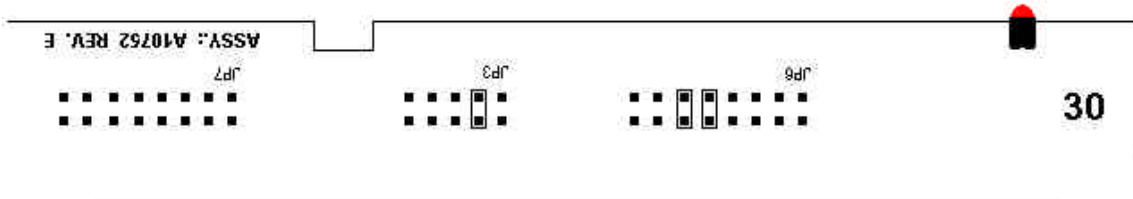

A2 - B2 - C2

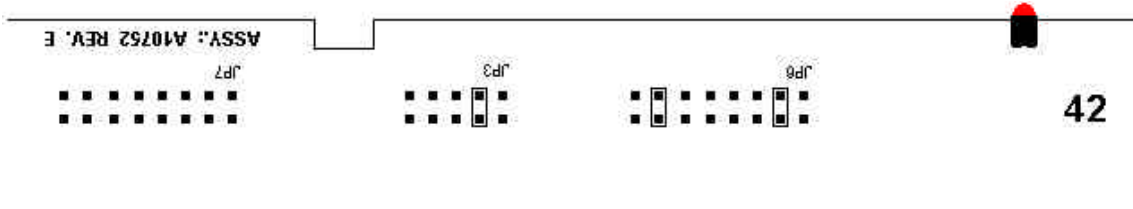

A3 - B3 - C3

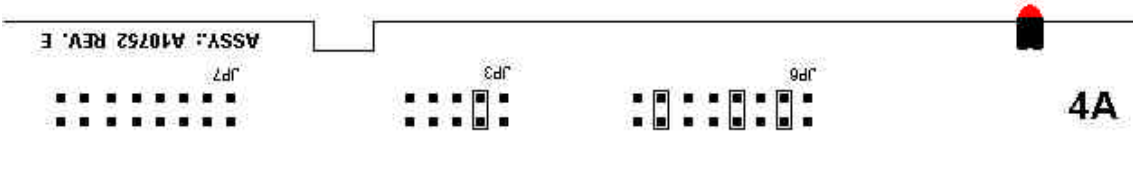

A4 - B4 - C4

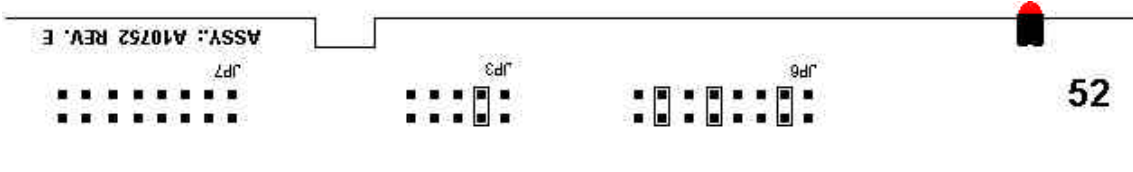

A5 - B5 - C5

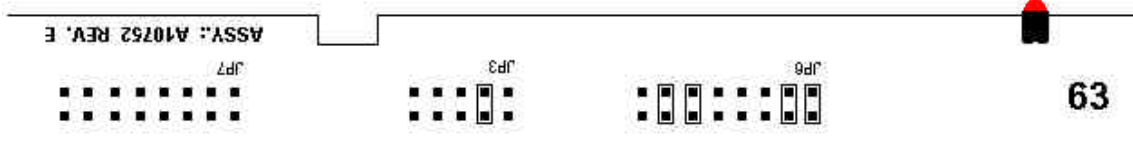

SARMU/STARMU
OPERATOR'S MANUAL

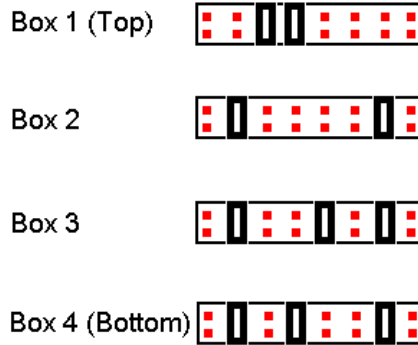
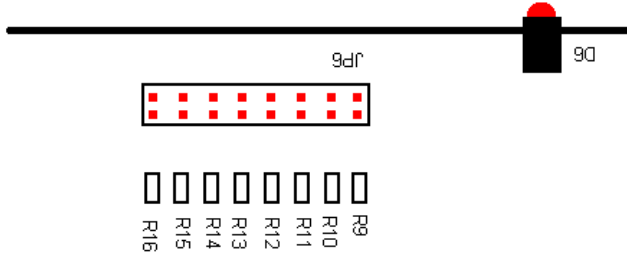

XCP Quick Start Guide

Cross Channel Main Page

(1)File - There are three options under the file menu. "Open", "Save" and "Exit". The Open Option pops up a little window that allows the user to select a Number. The numbers range 1-99. 99 different Crawls or Pages can be stored. The Numbers are static and can't be changed. After the user selects a number and presses enter, If the number that the user selected has a page or a crawl already stored in the "Crawl/Page Table" then the program will just open that Page or Crawl. If the number that the user selected is empty another window will pop up. This window asks the user what they would like to open, a Page or a Crawl. After the User selects one of the two options a new window will appear. The new window will either be a "Page" window or "Crawl" window depending on what the user selected.

* Page Window - On the Page window in the text box is where the user can enter what text they want to be displayed. Inside of the text box a "*" is equivalent to a space. So where ever the user wants a space to be displayed, they type a "*" instead of a space.

The user can enter in a name in the text box labeled "Name" to help identify the corresponding number. The user has the option to select what channels they want that page to go to when the "Send Crawl/Page" option is selected. When the user presses the Channel Select button and new window will appear. The user

SARMU/STARMU
OPERATOR'S MANUAL

then has the options to check the boxes next to the channels they want that page to go to when the table is sent out. Multiply Crawls or Pages cannot go to the same channel.

* Crawl Window - The Crawl window has a large text box for the user to type whatever crawl message they want to be displayed. The User can enter a name in the Name text box to help identify the corresponding number. The user has the option to select what channels they want that crawl to go to when the "Send Crawl/Page" option is selected. When the user presses the Channel Select button and new window will appear. The user then has the options to check the boxes next to the channels they want that crawl to go to when the table is sent out. Multiple Crawls or Pages cannot go to the same channel.

(2)Crawl/Page Table - This Table is what is sent out to the Star-8 units when the "Send Crawl/Page" option is selected. The user configures the Table before sending it to the Star-8 units. The user cannot fill out the Table manually in this Window. The user must open a Number and fill out the information and then save it to the Table.

Listing of Column Headers:

Num - This is just the Number to keep track of the 99 different Crawls or Pages.

Crawl/Page - Labels the Number if it is a Crawl or Page.

Name - This is the Name of the Crawl or Page that the user assigns. This is for the user to help keep track of their Pages or Crawls.

Text - This is the text for a Crawl message or the Characters that are stored for a Page.

If the Crawl is really long the user can click inside the "Text" box and press the arrow key over to see the rest of the characters. The message looks like it is cut off, but it really isn't.

Channels - The channels that were selected for this number are stored here.

Crawls Only:

Repetition - Repetition is the amount of times for the Crawl to repeat.

Speed - There are three options for the Crawl Speed. "Slow", "Med" & "Fast"

Position - This is the Position on the Screen that the Crawl will appear.

Instant Alert - This window is used for sending Emergency Crawls or Sending individual crawls to individual Channels. The user types in the Crawl they want and then the user can either send that Crawl to an individual channel or the user can press the "Emergency Send to All" button. The user also has the option to change the speed, Location and How many times they want the crawl to go across the screen. There is a Emergency Stop All button also. This button stops all Crawls on every Channel. The Emergency buttons take up to 2 minutes to perform their entire actions. The user must wait for the Mouse Icon to change from an hour glass back to an arrow.

The Cross Channel Promotion Frame is used to select pre-stored Crawls or Pages and send them to individual Channels. The user selects the Number of the Crawl or Page that they have previously saved and then they select what Channel they want that number to go to. When the user has selected the number and channel, they then press the "Send" button.

(4)Address Table - The Address Table is protected by a User ID:"keywest" and Password:"keywest" The Address Table holds the address for the Star-8 Channels. Also on the Address Table the Comm Ports are set to whichever Comm Port the User is using. The "Comm Port 2" is not used unless the user has more than 72 channels. Comm 2 sends commands out to anything above 72. The "Factory Recall" Option on the Menu bar is an option to Recall the factory addresses. The address can be changed to match the user's Star-8 Configuration. Contact Keywest Tech support for help.

(5)Control - There are three options under Control. Send Crawl/Page Table, Stop all Crawls and Clear all Pages. "Send Crawl/Page Table" sends out the Table that has been configured by the user. "Stop all Crawls" will stop every Crawl on Every page. This option will not clear any pages that are stored. "Clear all Pages" will clear all Pages that are stored on every channel. This option will not Stop any Crawls.

SARMU/STARMU
OPERATOR'S MANUAL

(6)Groups - The Groups Window is so the user can select a Crawl/Page Number and send that number to the corresponding channels that are selected. Each Grouping has a Send and Stop button.

(7)Modem Control - The first time you click on "Modem Control" a setup window will appear. Select the Modem that is in your computer and press "OK" This is for the DTMF option. The user pre-configures this window before trying to dial into the units. The user just has to click on Modem Control and configure it to their preferences and then close the window and they are ready to dial into the units. The Cross Channel BETA program must continue to run if a user wants to dial into the units. The program can run Minimized. The User must enter in the 5 digit passcode before being able to control the star-8's via DTMF. The passcode is pre-configured on the GUI. The user must also enter in the 5 digit codes for the other options before using DTMF. When the user just wants to send one Crawl and to One channel at a time, the user will press the Number they want first followed by the 2 digit Channel code and the "#" sign. and 4 digits followed by the pound will be read as Number and Channel. Example: "0108#" this series of digits will send crawl number 1 to Channel 8.

"*****" Erases Digits Received Box

"#####" Hangs up the Phone and logs the user off. or Just hang up