

LogoStar 300 HD

From



SYSTEM OPERATIONS MANUAL

KEYWEST TECHNOLOGY
14563 W. 96th TERRACE
LENEXA, KANSAS 66215
www.keywesttechnology.com
800-331-2019

Table of Contents

Description	3
Hardware Connections	4
Set Network Address	10
QUICK START	12
Import Logos	13
Add Sequences	14
Preview Sequences	16
Schedule Animations	18
ADVANCED PROGRAMMING	21
Edit Sequences	21
Special Effects	23
Change Path	24
Add TEXT	28

LogoStar 300

The LogoStar 300 HD is a powerful entry in low-cost HD motion logo generation. The unit is a logo insertion device with animation, keying, instant take and scheduling capability. The LogoStar 300 HD is capable of displaying logos of various graphic formats (.bmp, .jpg) at 24-bit true color levels, as well as enable the user to add custom text effects for date and time stamps, branding and messaging. The simple to use scheduling and creating software is installed on any Windows© based PC and connects to the LogoStar 300 for control via Ethernet, Serial, or USB Modem (optional), making the system the only all-in-one turnkey solution for high quality HD motion logo's at such a truly affordable price.



Specifications

SDI Video Input	2 x 10-bit BNC female. Supports single link 3 Gb/s and single link 4:2:2/4:4:4 and dual link 4:4:4.
SDI Video Output	2 x 10-bit BNC female. Supports single link 3 Gb/s and single link 4:2:2/4:4:4 and dual link 4:4:4.
Supported Video formats	525 NTSC, 625 PAL, 720HD, 1080HD and 2K switchable.
Analog Video Input	Component YUV/S-Video/ Composite switchable between SD and HD in Component.
Analog Video Output	Component YUV/S-Video/Composite switchable between SD and HD in Component.
HDMI Video I/O	Direct HDMI connection Optional
Sync Input	Blackburst in SD or TriSync in HD.
HD Format Support	1080PsF23.98/24, 1080i48, 1080i50, 1080i59.94, 720p59.94, 720p60 and 720p50.
SD Format Support	625/25 PAL, 525/29.97 NTSC and 525/23.98 NTSC.
SDI Compliance	SMPTE 292M, SMPTE 259M, SMPTE 296M, SMPTE 372M, SMPTE 425M-B, ITU-R BT.656 and ITU-R BT.601.
Video Sampling	4:2:2 and 4:4:4
Color Precision	4:2:2 and 4:4:4 10 bit
Color Space	4:2:2 YUV and 4:4:4 RGB
Copy Protection	For legal reasons, devices are designed not to capture, convert or transmit video or audio from copy-protected sources, e.g. video devices using HDCP.
Colorspace Conversion	Hardware based real time.
HD Down Conversion	Select output to use Dual Link 4:4:4 or select high quality down converter with HD-SDI on SDI A output, and SD-SDI output on SDI B output. Down Converter is always active when working in HD with the analog output selected to S-Video or composite. Selectable between letterbox, anamorphic 16:9 and center cut 4:3 styles.

CAUTION

Unit operates on 115 – 220 VAC, 50/60Hz. Inadequate power grounding can result in equipment damage or destruction and could void warranty. Ensure you utilize provided internal power supply unit only. Use of improper replacement power supply can damage or destroy the unit and will void the warranty.

*******WARNING*******

Lethal operating voltages present at system power supply unit—internal and external units. Completely disconnect main power cord prior to opening cover or removing any panels. Appropriately trained personnel only should attempt any internal modifications, repairs, or service.

HARDWARE

Rear Panel Overview

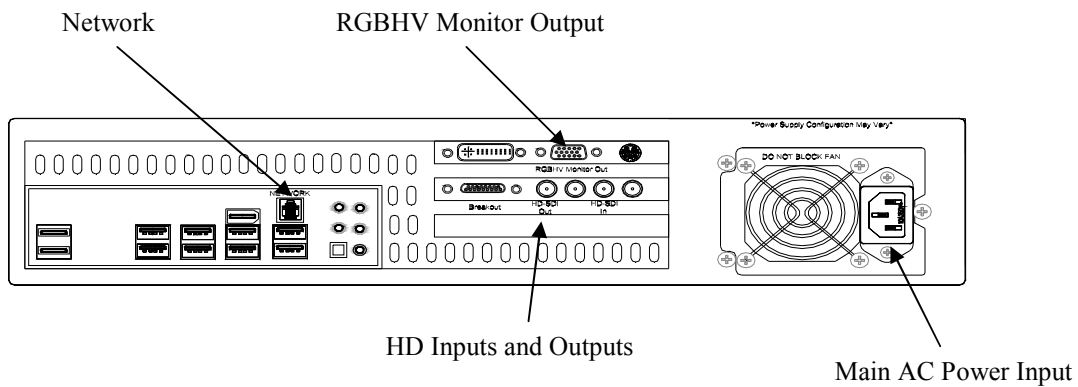

*Note: Component, CV, Y/C, Audio and Sync Signals are connected to the device by the included and labeled break out cable.

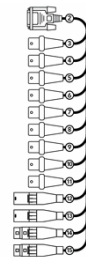

Standard PC Connections (refer to figure 1)(* = required connection for

LogoStar 300 normal operation; + = required for initial setup (Configuring Network, etc...); all other connections not marked with ‘*’ or ‘+’ are optional)

+MOUSE: USB

+KEYBOARD: USB

USB 1 & 2: Universal Serial Buss (any number of add-in peripherals such as printer, mouse, keyboard)

+RGBHV: This is the normal VGA-style connector. It is an industry standard High-Density 15pin connector, used to interface with any computer monitor. Video output of this connector is not meant for a television, as it is progressive scan component type video (as opposed to composite video on the RCA jack).

+NETWORK: This is a 10/100 Base-T LAN connector. Connect your LogoStar 300 to your network via this port, to allow for remote control of the device.

Should LogoStar 300 be shut down through normal Windows™ means, you’ll need to power the unit with the front panel momentary power switch. To do so, simply press the black rocker switch hidden below the right-hand front door. You should hear the fans begin to run, and LED indicators on the front panel should illuminate.

Should LogoStar 300 suffer a power-loss while playing its schedule, it will resume that schedule when power is restored.

SET IP ADDRESS

If you are connecting to the LogoStar 300 via a network, you will have to set the IP address in the LogoStar 300 according to your local IT directives.

Once the unit is running, and a logo sequence is playing, press ESC on an attached keyboard. This should reveal an embedded WinXP © desktop. Right click on the My Network Places Icon

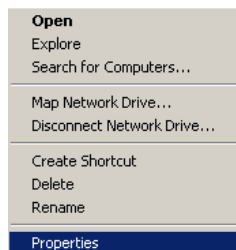

Then click on PROPERTIES

Next right click on the Network Connection Icon, and select properties again

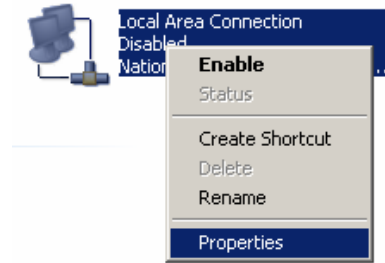

Select TCP/IP and click PROPERTIES one more time...

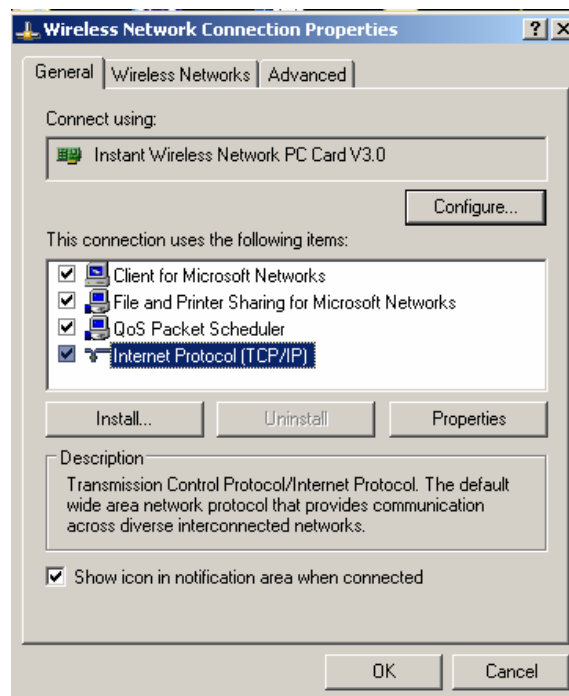

At this point, if you are not clear on exactly what to set, contact an IT professional before proceeding.

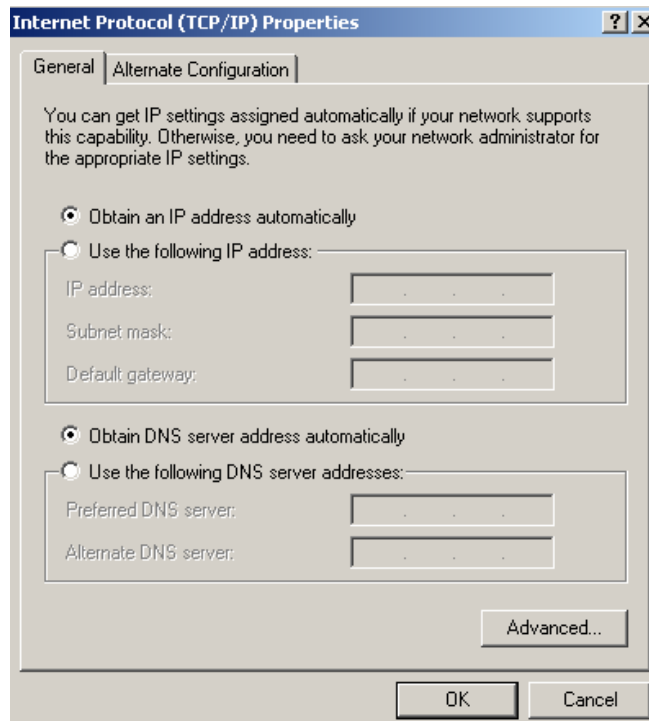

LogoStar 300 Scheduler Software Quick Start

This portion of the manual is geared at getting your logo on air quickly. This guide assumes that you have already completed the hardware installation and connections in the previous sections.

INSTALL SOFTWARE

Step one is to install the software. Insert the CD that came with your LogoStar 300 into the CD drive of the PC that you are going to use to control the LogoStar 300.

Follow all the Install Wizard's prompts. Allow the wizard to install the XML Parser and bring you up to DirectX version 9.0 if necessary. These modules are essential for success.

CREATE & PLAY

Let's first take a look at all the sections of the GUI and then we'll go through a simple exercise to get a logo on air.

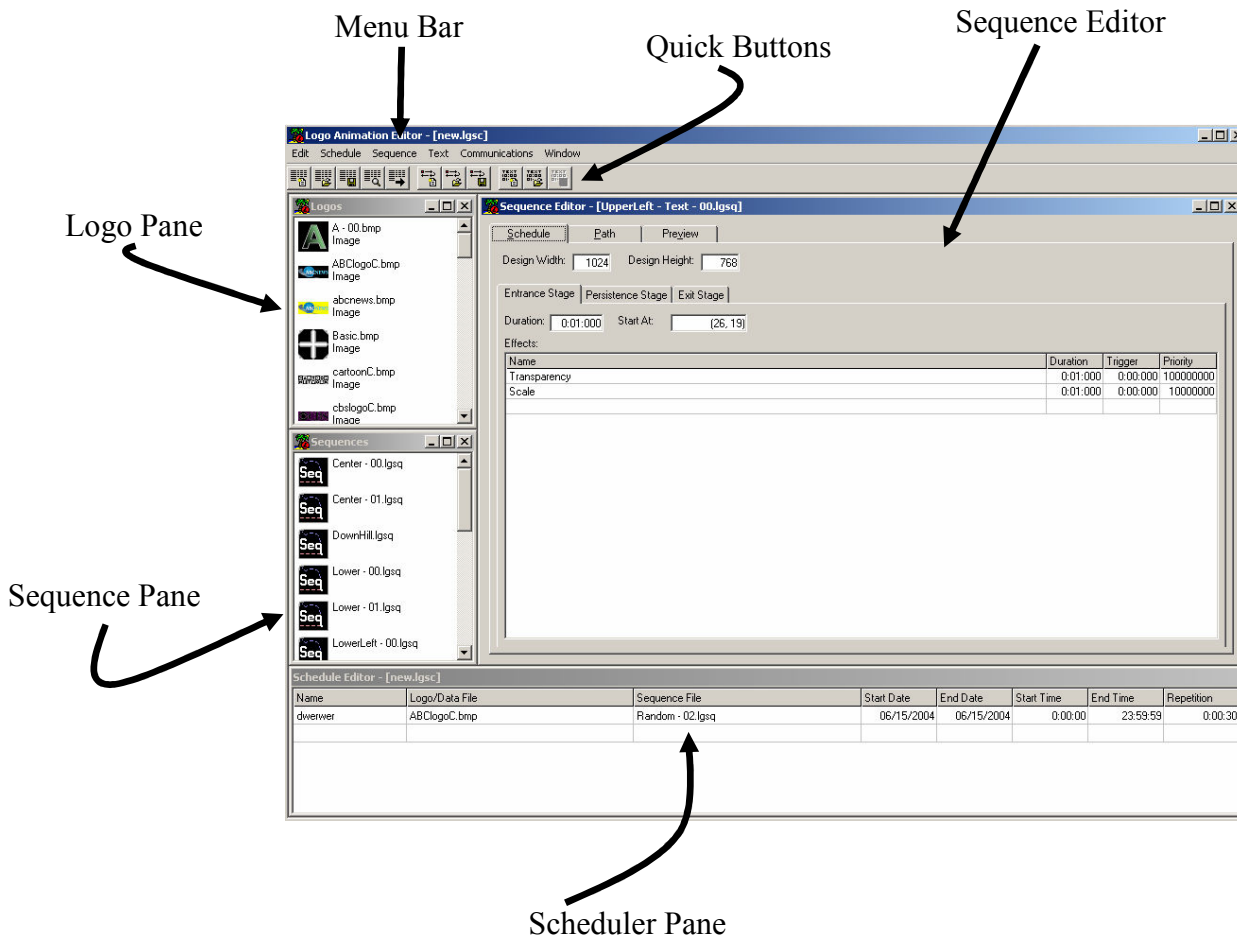

It is a must to know your environment, if you're going to be successful. The LogoStar 300 environment is an easy to use Graphical User Interface (GUI) that allows for importation of logo graphic files, creation of animation sequences, creating logo payout schedules, and communications with the LogoStar 300 device.

QUICK START

Later in the manual we'll cover some sections of the GUI that have advanced features more in depth. For now though, our goal is to get your first logo animation on the air.

Step 1: Import Logos

The LogoStar 300 software comes with several industry sample logos to experiment with. But, for your channel, you'll no doubt have your own logo.

Your logo can be of any size bmp or jpg, and can be 24-bit true color. True black (0 Red, 0 Green, and 0 Blue) is the key color for the logos. Any portion of your logo that is black will be keyed out and live background video will appear through.

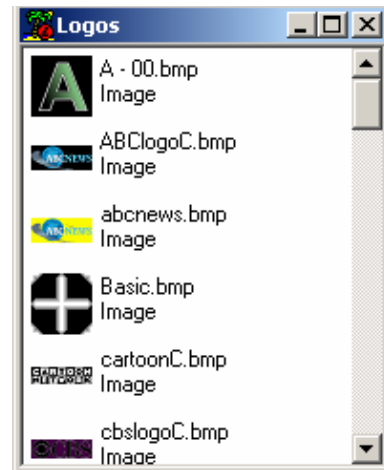

To import a logo, click the FILE menu Item and select import logo.

Set File Types to IMAGES for best results—you can import logos from any connected drive

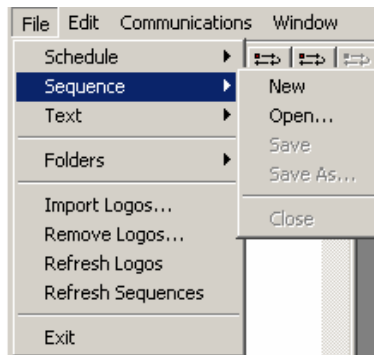

Your logo should now appear in the Logo Pane.

Step 2: Insert Logo into Schedule

Left click on any logo in the and while holding down the left mouse button (this assumes you have your mouse set to “Right Handed”) drag the icon down to the Scheduler Pane into the Logo/Data File column

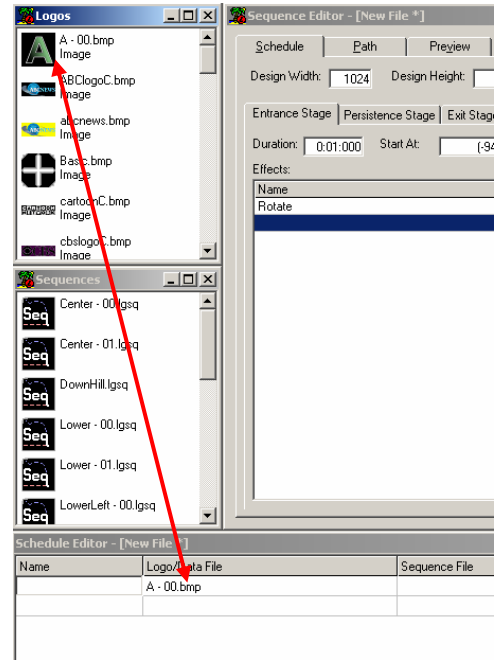

As shown in the illustration, your logo’s name will appear in the Logo/Data File column when the drag operation has been successful.

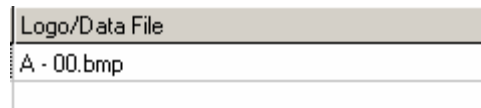

Congratulations, you are close to having a logo on air!

Step 3: Add Sequence

Once your logo is selected and in the schedule, you’ll need to tell it what to do! From a simple sequence, such as the logo appearing in the bottom right corner and remaining permanently, to a complex sequence of movements and motions, you can create and schedule them all. The LogoStar 300 comes with a set of “pre-recorded” sequences that you can start with. Later, in the advanced section of the manual you’ll discover how to create your own sequences.

Pick one of the sequences from the sequence pane. You can

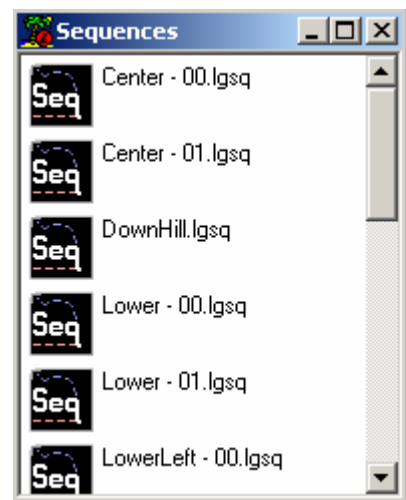

preview the sequence by double left clicking on its thumbnail—the selected sequence will load into the Sequence Editor Window.

To preview the sequence, click the PATH tab in the Sequence Editor window.

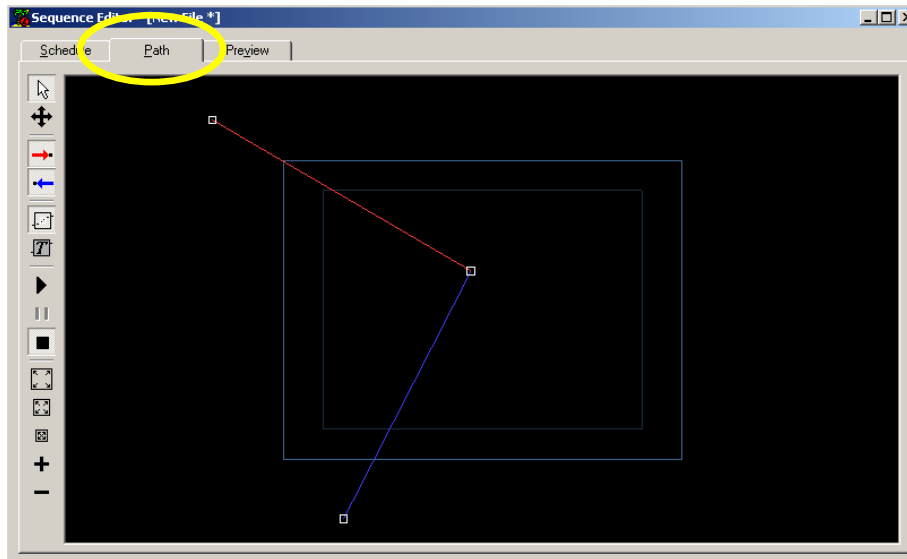

Notice on the left edge of the PATH window several buttons...these are the controls for the PATH window:

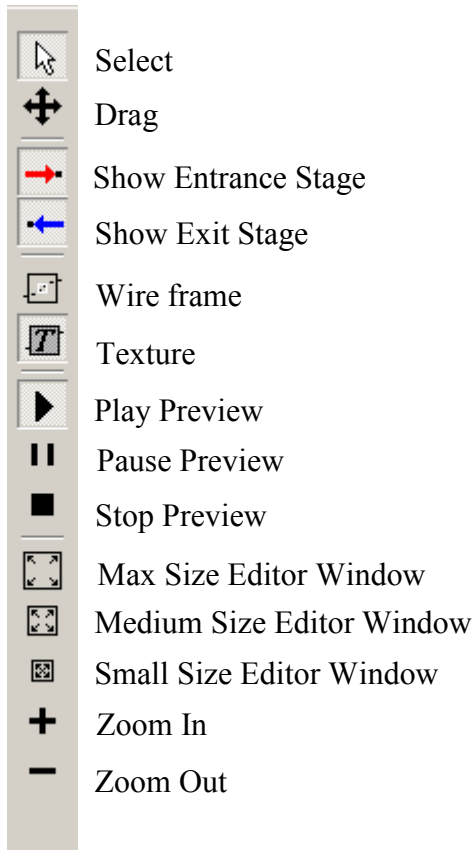

Click the PLAY PREVIEW button (as shown above). The white box you see is a representation of the logo itself. This is wire-frame mode.

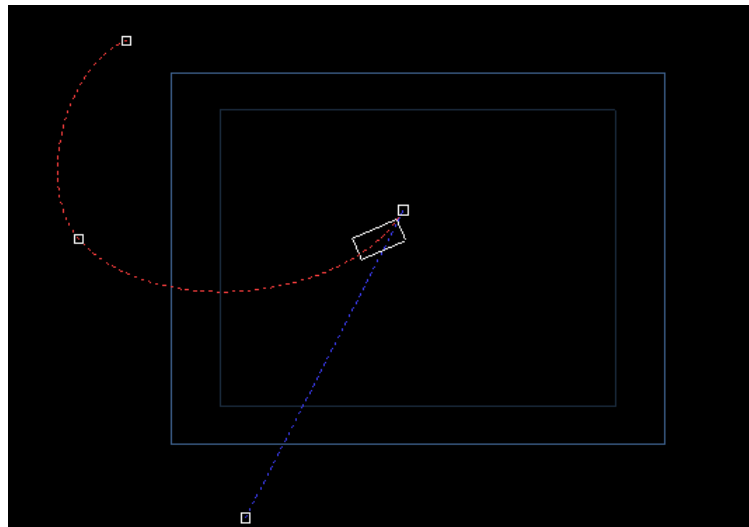

If you would like to see your actual logo in the preview window, drag it from the logo pane to the Editor window while the preview is playing. The selected logo will replace the wire frame.

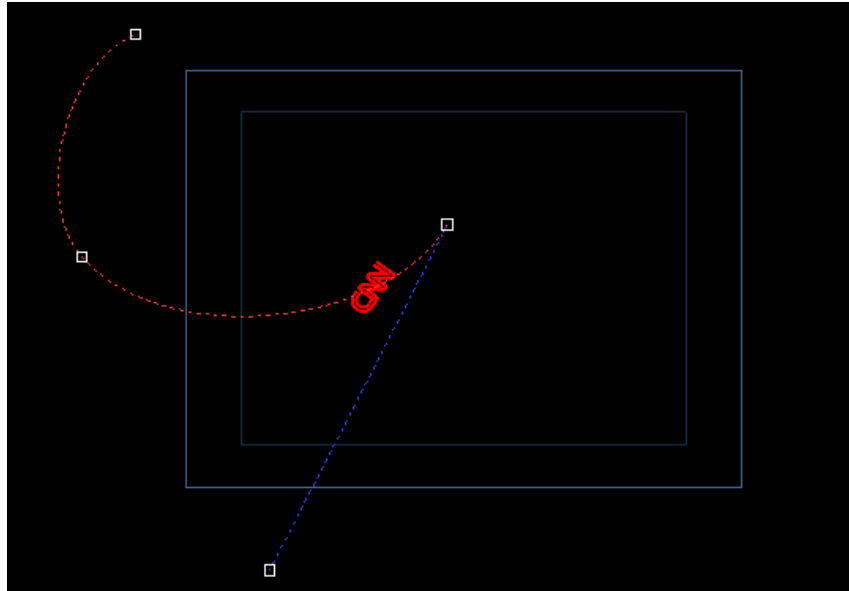

To stop the preview, click the STOP PREVIEW button on the Sequence Editor Button column.

Now, once you've selected the sequence to use, you will need to drag it to the Scheduler Pane just as you did with the logo (mouse left click and drag and drop).

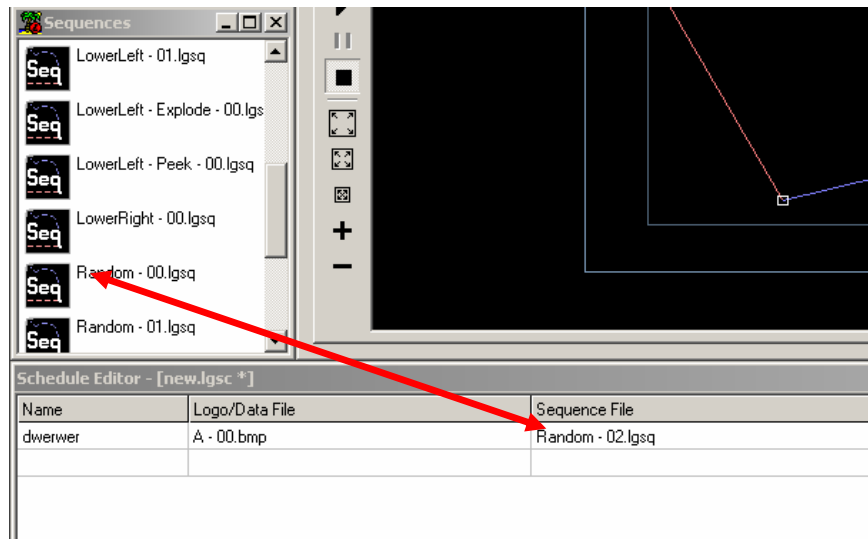

Step 5: When and How Long to Play?

Getting close. Now that you have selected a logo and programmed it where to play, you'll have to program it when to play—and how often.

The last five columns of the Scheduler Pane are used for those settings—START DATE, END DATE, START TIME, END TIME, and REPITITION.

Name	Logo/Data File	Sequence File	Start Date	End Date	Start Time	End Time	Repetition
dwerwer	ABCLogoC.bmp	Random - 02.lgsq	06/15/2004	06/15/2004	0:00:00	23:59:59	0:00:30

START DATE—First effective date of the scheduled element (this individual logo schedule)

END DATE—Last effective date of the scheduled element

START TIME—Exact first effective time logo will run

END TIME—Last effective time logo can run

REPITITION—Effective time logo will repeat (based on exact seconds)

Alright, this is an area that requires a bit of study and explanation. Start date and end date are simple enough, but when you schedule a logo and you want it to run intermittently, then programming is what you'll do.

We'll have to make some assumptions for the sake of the manual, but you can get more specific in your actual programming. First, set the Start Date and End Date to your desired time frame. You adjust these dates by double clicking in their respective cells and then selecting from the pop-up calendar.

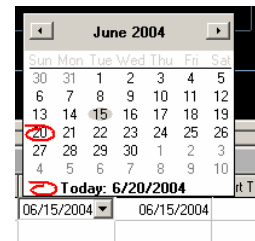

Next, you'll set the time—for your first go, it's best to select 00:00:00 (midnight) to 23:59:59 (midnight minus one second). You can get more specific in these times by double clicking in their cells and using the up and down arrows to adjust the clock elements.

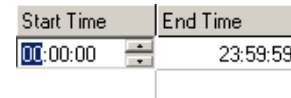

Finally, there is the REPITITION column. This is used to set how often the logo sequence repeats itself. Adjust that time exactly as done with Start and End times—double click the cell and use the up and down arrows to set the clock elements.

Now we have to put all of that knowledge to use. Let's say you are creating a schedule that you wish to run every 10 minutes on the minute. You already have the dates and valid times of day set...but there's one very important factor. If you want the sequence to run at 10, 20, 30, 40, 50, and 00 of every hour, then the Start Time MUST be hh:00:00 (where hh is any hour you wish to start this program) and Repetition MUST be 0:10:00.

Here are a few more examples to clarify the scheduling

<i>Logo to Play Every Hour at 30 Seconds Past the Hour</i>				
Start Date	End Date	Start Time	End Time	Repetition
6/15/2004	12/31/2004	00:00:30	23:59:59	1:00:00
<i>Notice the START TIME is setting the trigger to be at the 30 seconds past the hour point</i>				

<i>Logo to Play Every 15 Minutes all day</i>				
Start Date	End Date	Start Time	End Time	Repetition
6/15/2004	12/31/2004	00:00:00	23:59:59	0:15:00
<i>OK, easy one! But, illustrates again relationship between Start Time and Repetition</i>				

<i>Logo to Play Every 10 minutes from Noon to 4:00 PM</i>				
Start Date	End Date	Start Time	End Time	Repetition
6/15/2004	12/31/2004	12:00:00	16:00:00	0:10:00
<i>One note on this one...the logo will play one last time at 16:00:00 (4:00 PM)...so if you wanted the last play to be at 3:45 PM, you'd have to adjust End Time accordingly</i>				

<i>Static Logo to permanently remain on screen</i>				
Start Date	End Date	Start Time	End Time	Repetition
6/15/2004	12/31/2004	00:00:00	23:59:59	0:00:00
<i>This would require a sequence that has no motion elements and the stages sum to at least one second</i>				

We're quite sure that you will come up with different combinations and cool tricks that we've not thought of. You've probably got a good idea how it works already, so dig in, experiment, and discover.

Step 6: Save it, Send it, Play it

So, the schedule is created, and it runs on your local PC, and you're ready to go on air with it. This is where communications comes into play. But first, save the schedule—either click the SAVE SCHEDULE Button



Or click the Schedule Menu item and select Save (or Save As).

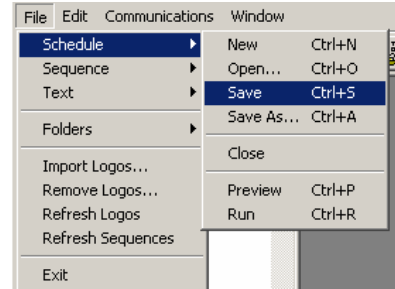

Next, open the Communications Menu Item

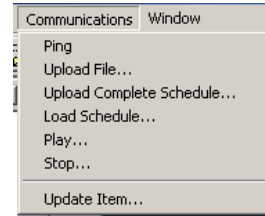

We assume in this part of the manual that your LogoStar 300 is already installed, all the proper connections have been made, and you have some sort of connection to it (network or serial).

It is a good idea to test the connection—in the Communications Menu drop-down window, select Ping.

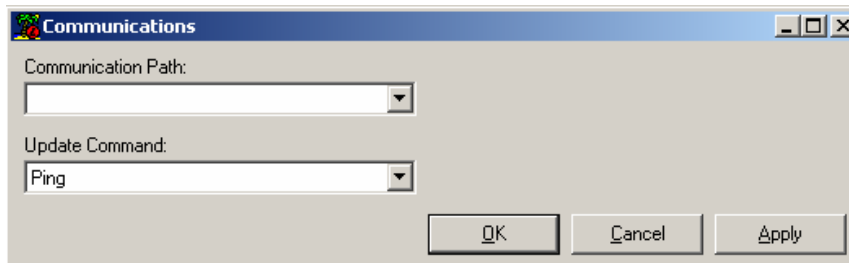

In Communication path, you have some choices. Click the down arrow and select any of the COMM ports that you are using to communicate with the LogoStar 300. If you are connecting via network, enter the IP address of the LogoStar 300 in the Communication Path box

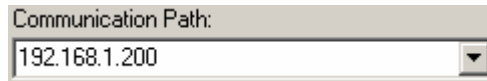

Note: This is just a sample IP address—yours will probably be different—check with those who installed your LogoStar 300 or your IT people for more details

Make sure the Update Command window still displays “Ping” and click OK.

Now that we're sure the communications path works well, it's time to get your logo live, on-air.

Click the Communications Menu item again, and this time select Upload Complete Schedule. Note, this will only load the schedule on the LogoStar 300. It will not start playing your new schedule until you send the Load Schedule and PLAY commands—so, go ahead and send both of those commands now!

That's it. You have just placed your first Logo on air from the LogoStar 300. We hope it was an easy enough process—but, if you have suggestions or issues, don't hesitate to contact Keywest Technology for further assistance.

Advanced Programming

Sequence Creation

In the quick start section of the manual, you used preloaded sequences. One of the most powerful functions of this software is the ability to create and use your own sequences.

This manual assumes that you have already gone through all previous sections and are familiar with the basic operation and connectivity of the unit.

To get started creating your own animation sequence, click the Menu Item SEQUENCE and then click NEW.

If the Sequence Editor window wasn't open before, it is now.

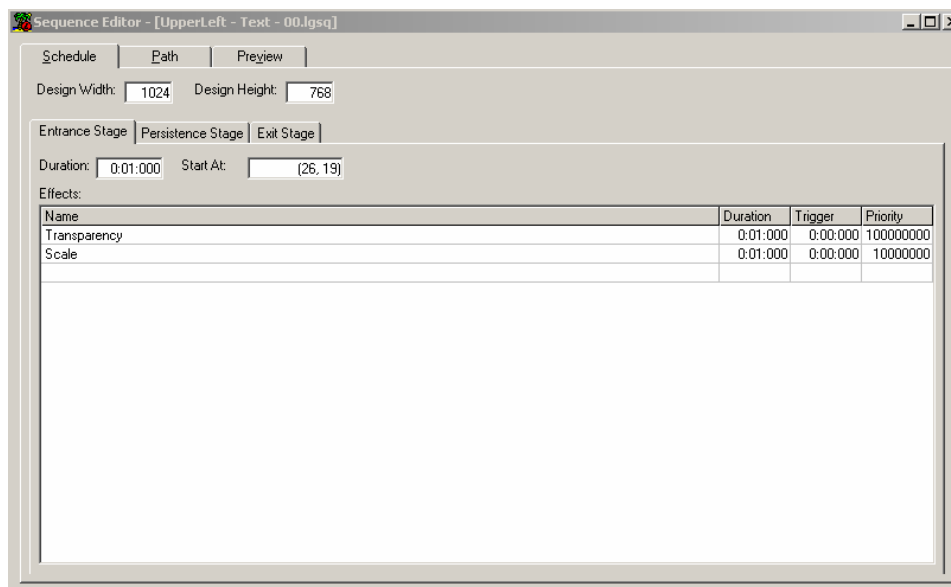

The first Tab is SCHEDULE. Schedule is the schedule of events for this particular sequence. It has 3 Sub-Tabs: Entrance Stage, Persistence Stage, and Exit Stage.

The LogoStar 300 animator operates in these 3 stages. Entrance is of course how the logo enters the screen (Slides In, Fly's In, Rolls In, Just Appears). Persistence is the stage where it makes it's Cameo...where it sits on the screen for a set amount of time, so your viewers can get a good look at your brand—Special Effects can be applied in the Persistence stage just as they are in Entrance and Exit. Exit is how the logo leaves the screen (same kind of effects as entering).

SETTING ENTRANCE, PERSISTENCE and EXIT STAGES

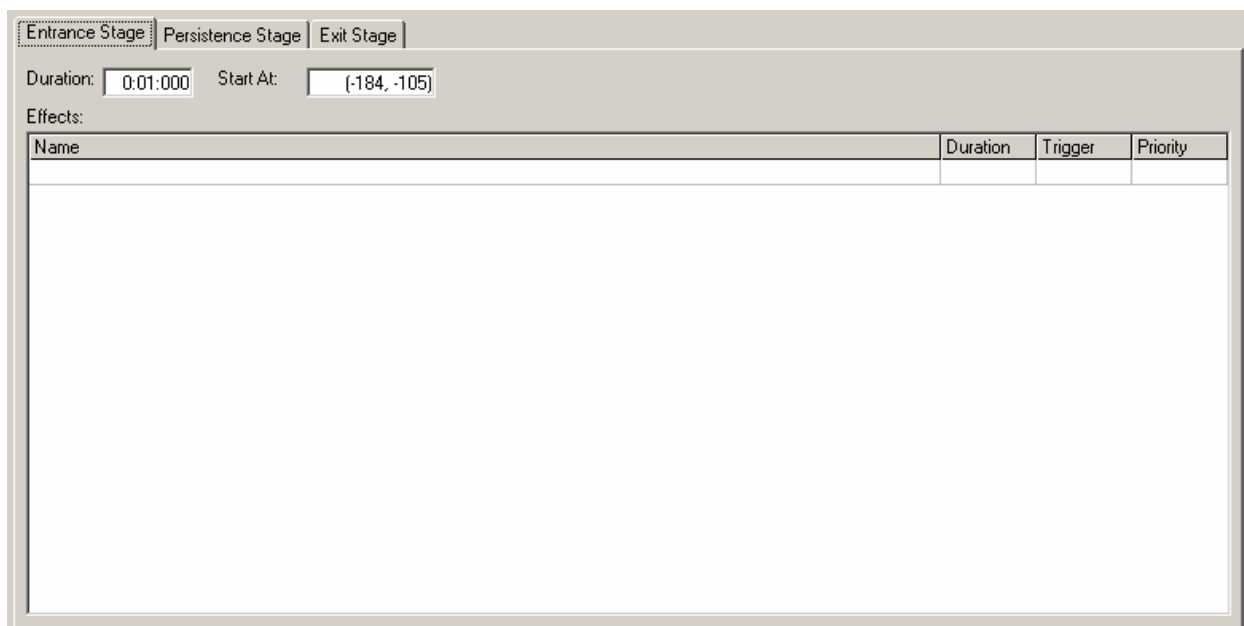

Under the Entrance Stage tab, there are several settings that you will adjust. First is the Duration window. Click in the Duration window and type in a time from 24:00:000 (24 hours) down to 0:00:000 zero seconds. This Duration is the time the logo takes to complete the Entrance Stage—so, yeah, if you set it to 24 hours, it will take all day to enter, and by that time, will surely conflict with itself. A normal setting for this is 1 second (30 frames). That means that the entire entrance stage (represented by the Red Line in the Path Editor) will take 1 second to complete.

Therefore, if you wish to slow down the entrance of your logo, either shorten the path it travels or extend the duration time.

START AT can also be adjusted here. This coordinate is the starting point of the logo based on your editor window and not on the TV display itself—so 0 is the left most or upper most point in width and height respectively.

You'll notice, when you adjust the path nodes in the path window, these start and end numbers change accordingly.

Once you have set the Duration and the position settings (if you desire any changes there at all) the next step is to add any special effects to the entrance stage if desired.

Special effects are created by Keywest Technology. Additional effects may be added at a future time. Keywest Technology will also create custom effects for you—call for a quotation.

In the Effects window, click in the NAME cell. The list of available effects will appear.

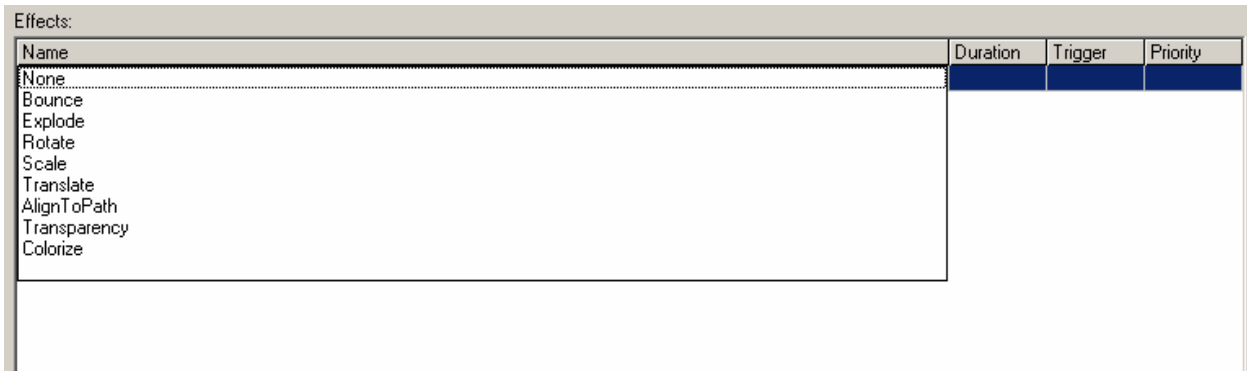

You can add multiple effects to the entrance stage—for example you can add bounce and rotate—the result will be a logo that bounces and rotates as it follows the entrance path onto the screen.

To customize an effect, right click on it after it is entered into the Effects window. Select Customize—each effect will have a set of parameters that can be adjusted and tweaked.

Here is a brief description of each effect (however, the best way to gauge the action of an effect is to add it to a sequence and preview it in the PATH window):

- Bounce: Logo follows an arcing vertically ascending and descending path
- Explode: Logo will “explode” into preset number of pieces which all fly away
- Rotate: Logo “spins” about its center point in 2D
- Scale: Logo changes in size (gives appearance of 3D or Z-Axis Movement)
- Translate: Logo angle of view changes (left to right movement about a vertical axis)
- Align to Path: Keeps the horizon of the Logo at same angle as Travel Path
- Transparency: Fades the Logo In and Out
- Colorize: Changes the RGB and Alpha properties of the Logo as it travels

Click the PERSISTENCE STAGE tab on the Editor window. Notice the settings are exactly the same as the ENTRANCE STAGE.

While a logo is in Persistence, it does not travel along a path. It becomes static for the programmed amount of time. The logo can play out an effect however during persistence.

For example, the logo can persist at a certain spot, and all the while be bouncing. Very effective attention getters!

Program the Persistence Stage as you did the Entrance Stage.

Click the EXIT STAGE tab on the Editor window. Notice settings are exactly the same as they are in entrance and persistence stages. Set your durations and effects similarly and as desired.

PATH WINDOW

We briefly examined the Path Window earlier, in the quick start section, but now it's time to get more in depth.

Associated with the SCHEDULE tab in the editor window, the PATH tab is where the sophistication is added to your sequences.

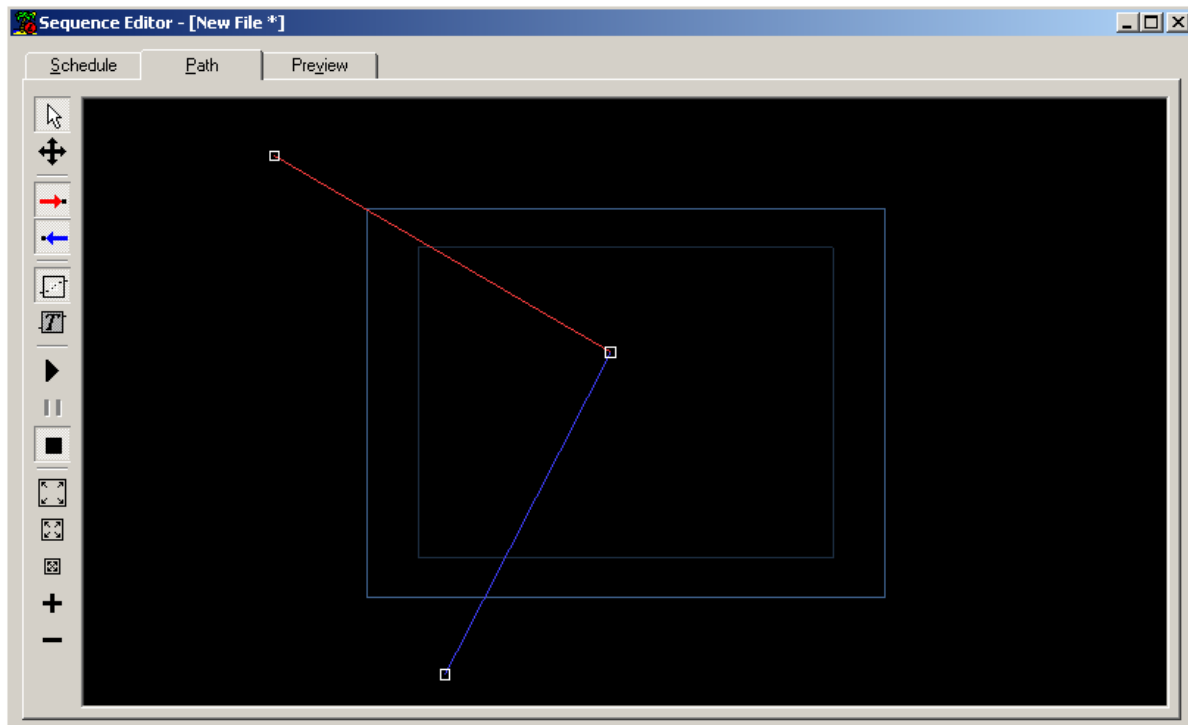

The red colored line represents the Entrance Stage. The blue colored line represents the Exit Stage. The junction of the red and blue lines is the persistence position. Nodes are represented by small white boxes. These are points of control for each stage.

Left click on any node and drag it around to position desired.

Right click on the editor window and the add node window will appear. Here you can add a node to either entrance or exit stages (persistence is what it is...no nodes can be added to persistence).

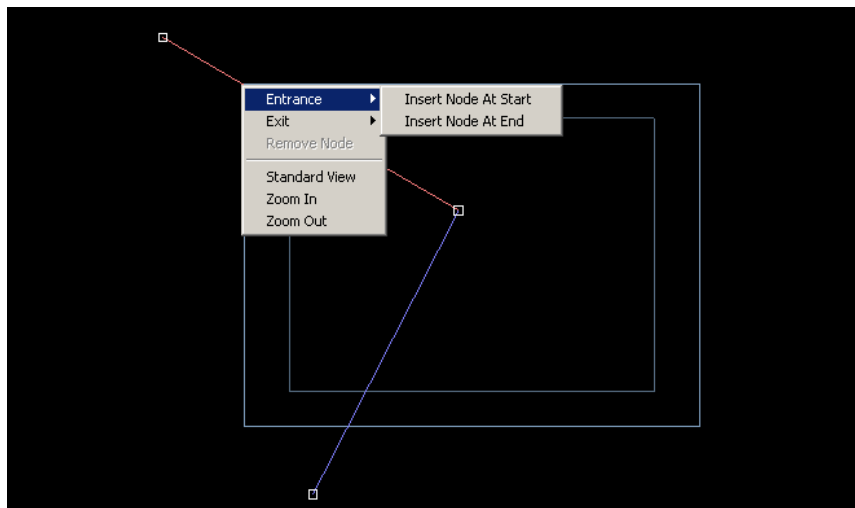

Once new nodes are added you can drag them to create curved splines.

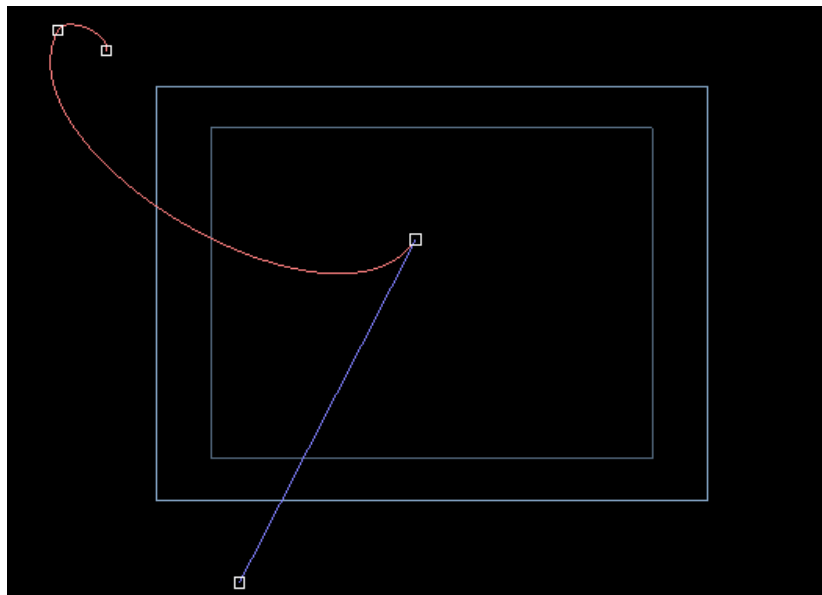

For a true dynamic preview of your creation, you can turn on the preview in the Path window by clicking the Play Preview Button. Even while the preview is in motion you can drag nodes to create new paths.

If the wire-frame box is not a good enough preview, then drag your logo into the editor window...your actual logo will then serve as the preview.

PREVIEW WINDOW

In the Path tab of the editor window, the preview ignores the persistence stage for efficiency. To see a true, full preview, click the Editor Window's PREVIEW tab. This will preview the entire sequence, although no editing is allowed in this mode.

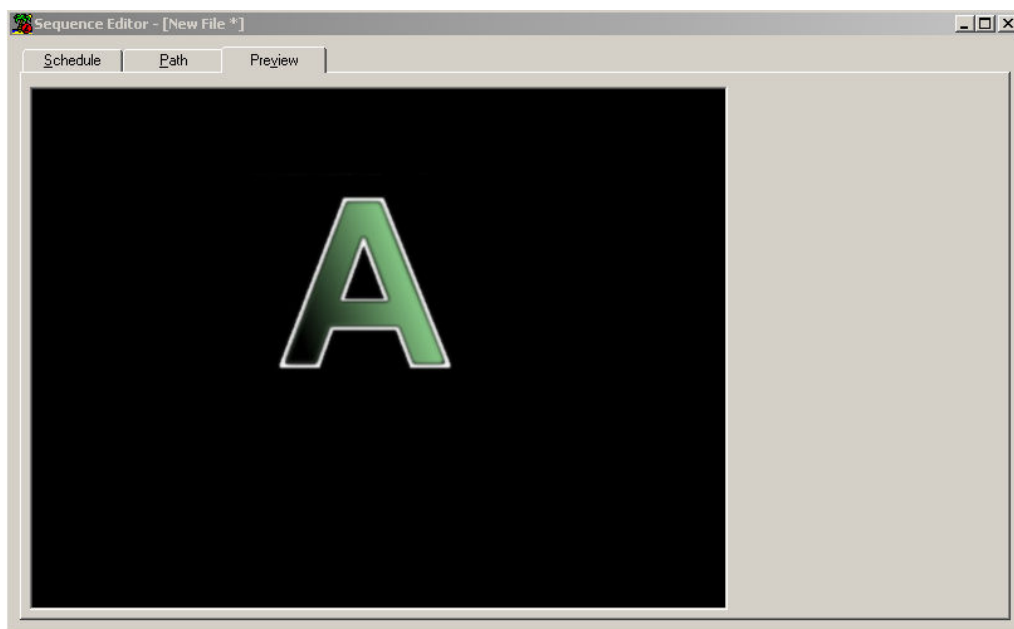

SAVE SEQUENCE

After you have created a sequence that you wish to add to your sequence library, click on either the Save Sequence button



Or the Sequence Menu item and select Save or Save As. After saving, you should now see this sequence in the Sequence Pane (this is your library of sequences).

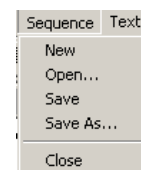

TEXT and VARIABLES

No logo presentation made for TV or any other video outlet would be complete without Date and Time capability.

LogoStar 300 can add date and time capability as well as other text blocks that can be used for messaging as well as branding and identification.

The text blocks act like and are treated like graphics logos.

First, to create a text block, click on the Menu Item TEXT then click NEW.

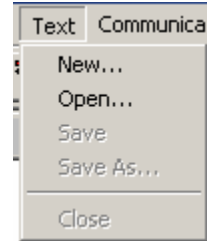

The text editor window will open. This editor window will allow you to create text, edit the fonts and properties, as well as utilized pre-set formats.

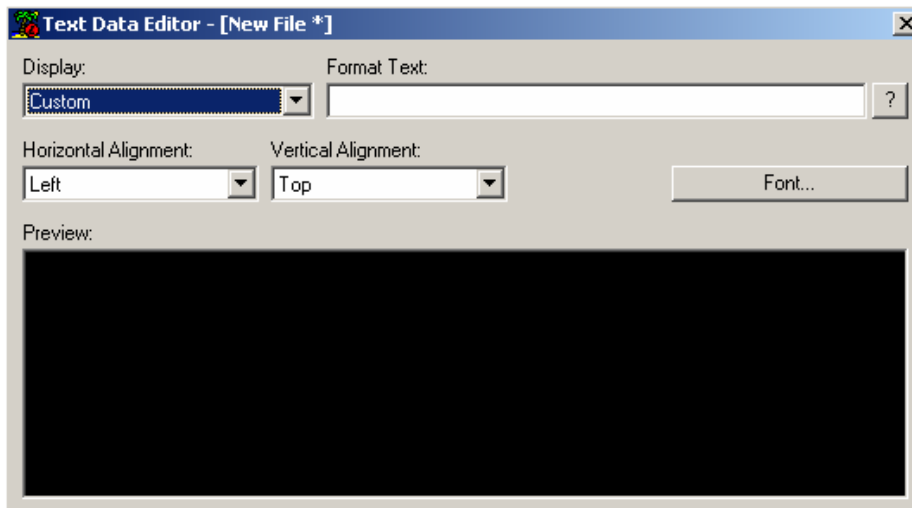

Click the down arrow in the DISPLAY box. Choose your format from any one of the preset designs

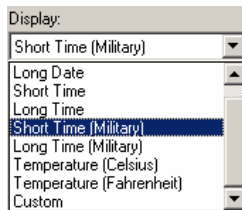

Use the FORMAT TEXT box to modify the text display or to create a custom message (could be used as a pager for instance!).

The Horizontal and Vertical Alignment boxes and drop-downs set the justification within the editor window only. Positioning on the final display is controlled by the schedule. You simply schedule a text item as you would a logo.

Adjust the parameters of the font in a text item by selecting FONT.

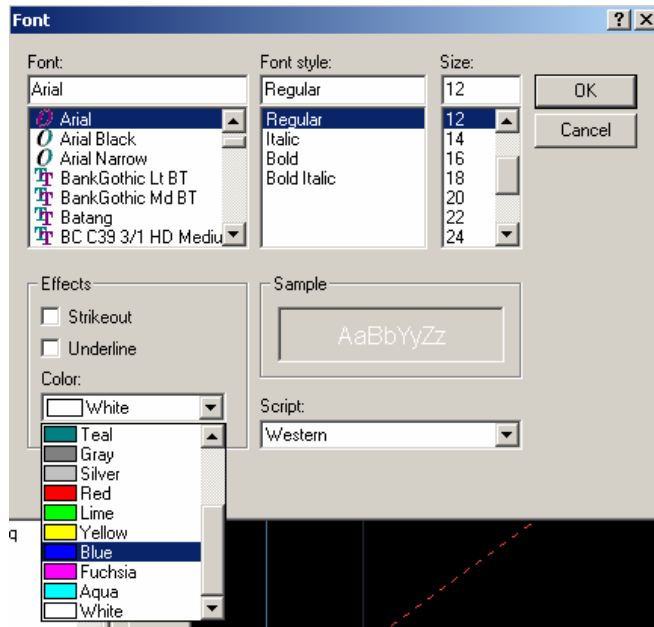

Here, you can change the Font, Style, Size, add Effects as well as set the color of the text to be displayed.

Once complete editing your text item, return to the TEXT Menu item, click SAVE. Your new text item will appear in the Logo Window as though it were a logo item. From this point, scheduling it to play is identical to scheduling a graphics logo.

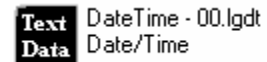

ADVANCED SCHEDULING

Up to now, you've scheduled only one item at a time to play on screen. But LogoStar 300 has the capability to display 10 items simultaneously.

We call this advanced scheduling, but it is as simple as scheduling multiple line items with concurrent validity times and dates.

Schedule Editor - [new.lgsc *]							
Name	Logo/Data File	Sequence File	Start Date	End Date	Start Time	End Time	Repetition
dwerwer	concord.bmp	lowerrightstatic.lgsq	06/15/2004	01/25/2005	0:00:00	23:59:59	0:00:00
text	Date - 00.lgdt	Random - 00.lgsq	06/20/2004	06/20/2004	0:00:00	23:59:59	0:00:30

The above example would display the concord.bmp with the lowerrightstatic.lgsq sequence and the Date-00.lgdt with a random sequence at the same time.

If we added 8 more items, all scheduled to play at the same time, we'd probably jumble up the screen to where the program video is unusable—but it is possible.

More than likely, you'll use the advanced scheduling to create a daily schedule. Something like one logo that at the 15's and a different logo that plays at the 45's.

That schedule would look like this:

Schedule Editor - [new.lgsc *]							
Name	Logo/Data File	Sequence File	Start Date	End Date	Start Time	End Time	Repetition
firstone	concord.bmp	lowerrightstatic.lgsq	06/15/2004	01/25/2005	0:15:00	23:59:59	0:01:00
newone	abcnews.bmp	Random - 00.lgsq	06/20/2004	06/20/2004	0:45:00	23:59:59	0:01:00

The only scheduler limitation is 10 simultaneous items. That is, only 10 items on the screen at one time. I repeat myself so it's clear that you can schedule hundreds of different events using hundreds (or even thousands) or different logos for years to come. The only limitation is really hard drive space.

INSTA-LOGO

Insta-Logo, or Play Sequence is a special mode for the LogoStar 300. This mode allows the user to pre-program six separate logos and sequences to the programming slot. The user can then do a simple Take and that logo will immediately appear on screen.

This function can be used to queue banners on screen (perhaps a name banner), or instant Logos, or trigger advertisement sequences with a single click.

To access Insta-Logo, click the COMMUNICATIONS menu item and select PLAY SEQUENCE.

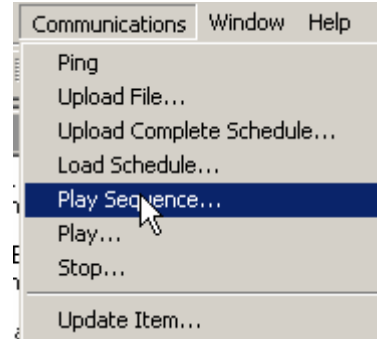

The main PLAY SEQUENCE window will open.

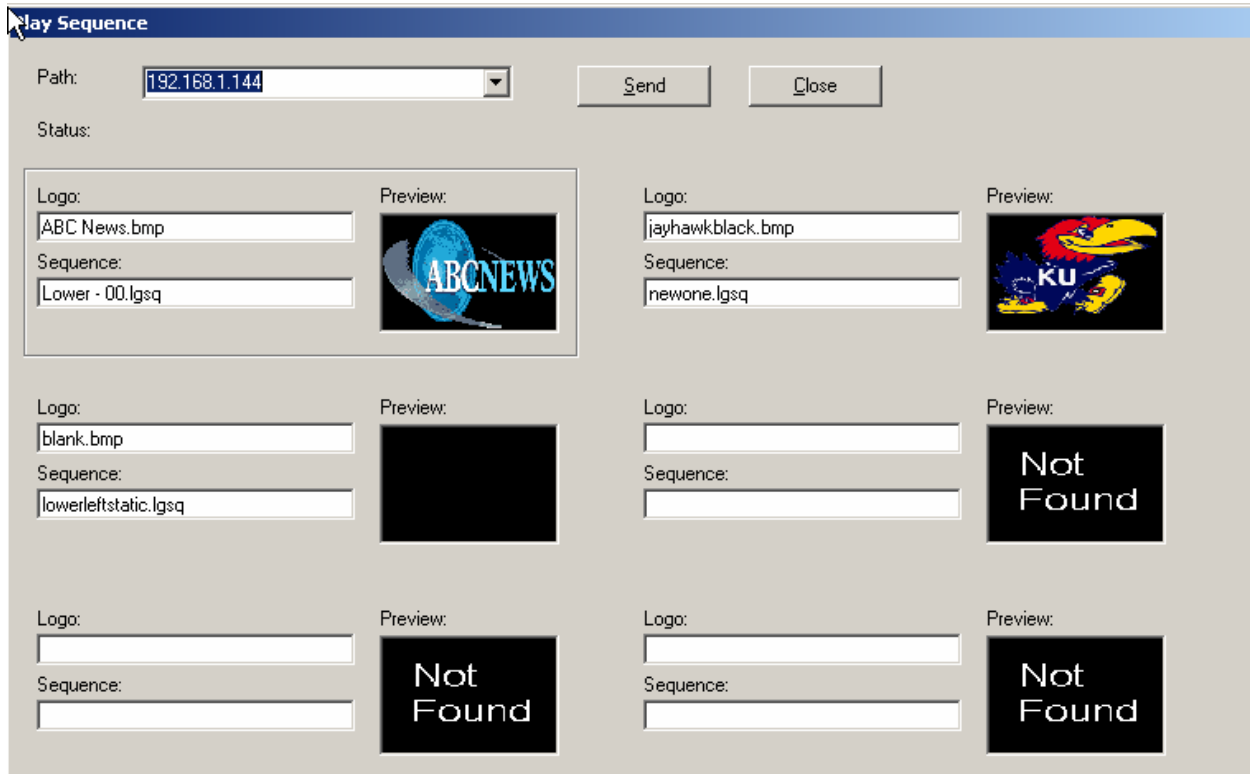

The full window view on page 26 shows the PLAY SEQUENCE window loaded with three logos and sequences. Any of the six slots can be loaded with any of your logos and sequences.

OPERATIONAL NOTE
Insta-Logo/Play Sequence will only function if the chosen logo and the sequence are already loaded into the LOGOSTAR 300 Player. Load the Logo and Sequence files utilizing COMMUNICATIONS and UPLOAD FILE

To load a slot with Logo and Sequence data, click anywhere in the text box area of the slot, as shown below.

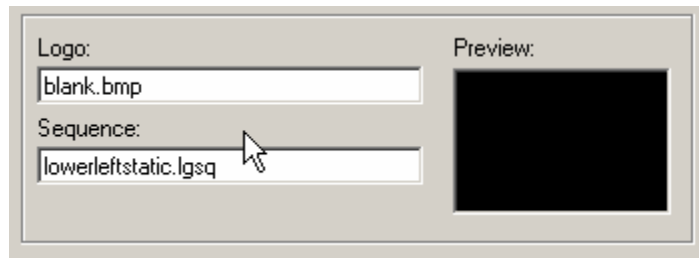

The slot is indicated as the active slot by the outline box around the entire slot data—below, the logo on the left is active, and the logo on the right is not.



To load data in a slot, click in the text box that you intend to load—for instance, if you want to load a new Logo, place your cursor in the Logo text box and click (you should see a text cursor in that text box now).



Next, choose the logo you wish to load from the Logo Clip Board Window, and double-click it.

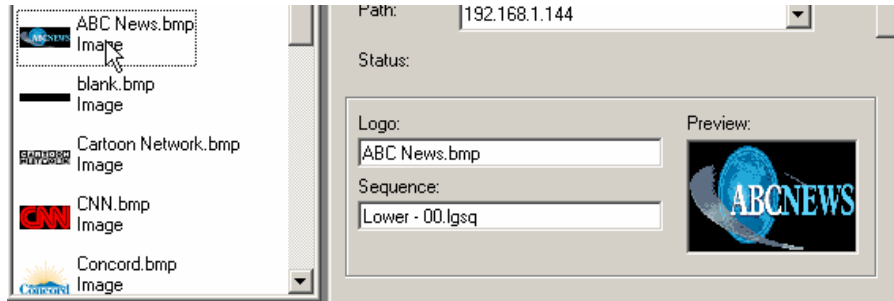

The logo text box will now indicate the loaded logo name and extension, and the preview box will show a thumbnail of the logo.

Load a sequence by placing your cursor in the Sequence text box, choose the stored sequence you wish to use from the Sequence Clip Board Window, and double-click it.

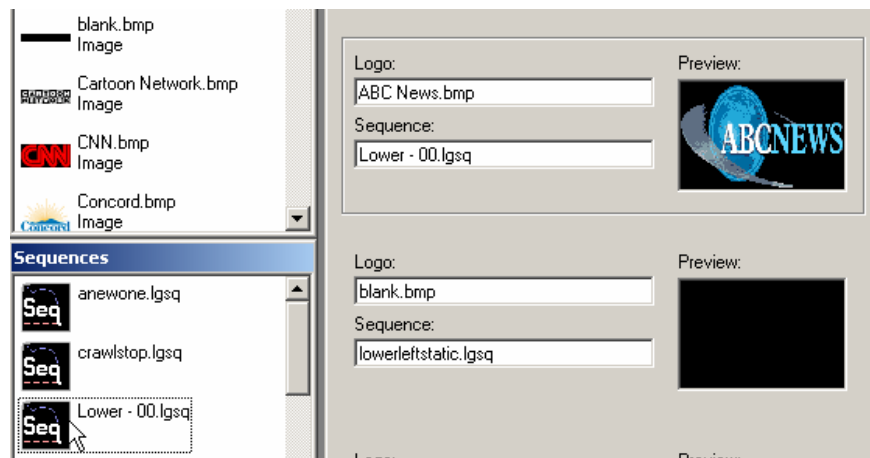

There is only one step left to enable triggering logo's and sequences at a single mouse-click, and that is to set the IP address of the unit you wish to send instant commands to.

At the top of the Play Sequence Window, choose the IP address you want, or type in a new IP address (the program will save all successful IPs you enter).

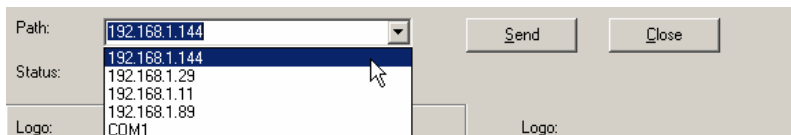

Everything required to send instant logo's to the player is now in place (remember, the actual logo file and sequence file must already reside on the player). To activate, simply click the SEND button at the top of the window, or click the slot's thumbnail. The command to trigger the programmed sequence and logo is immediately sent to the player.

In our example, notice one slot is a blank (black) logo, and any sequence. This slot is used to effectively turn-off a logo. For example, if the user is inserting name banners for live programming, the banner may be removed by sending the blank logo. To be completely keyed out, the blank logo must be true 24-bit black (0 Red, 0 Green, 0 Blue).

APPENDIX A: Camera ID System Operation

The LogoStar family is capable of special operations with hardware and software modifications. One such modification is the Camera ID System for use in professional golf broadcasts.

GUI

To access the Camera ID GUI, open the LogoStar 300 Editor GUI and click COMMUNICATIONS; select CAMERA ID SYSTEM.

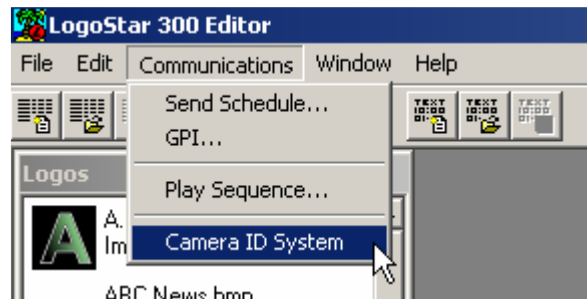

The CAMERA ID GUI will open; if it opens full screen, reduce to a Window view by using the standard windows controls in the upper right corner.

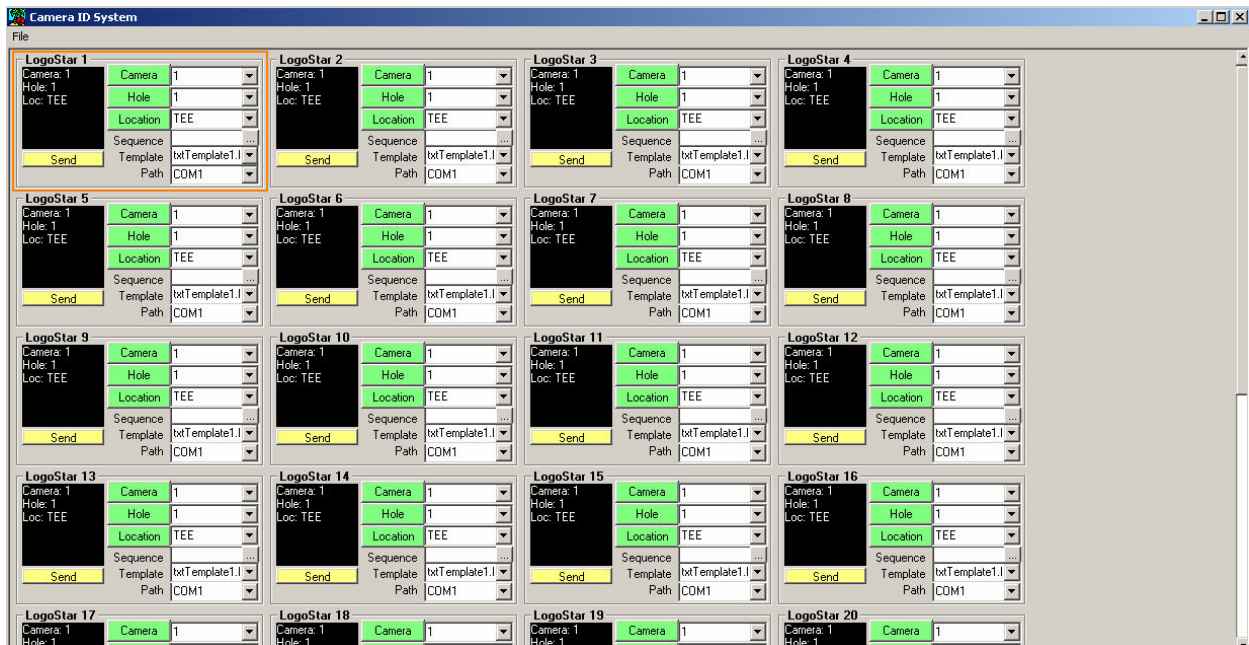

This GUI screen gives you control over multiple LogoStar units for multiple screen overlays. Each functional block controls a specific LogoStar unit.

Step 1: Set Path

This is the communications PATH between your controller PC and the LogoStar units. The default setting is COM1, which would be used for serial RS-232 connection. If you are connecting via a different COM port or via LAN, click in the PATH block and type the appropriate parameters—for our example, we would be connecting to a LogoStar over a network with the IP address 192.168.1.100 and therefore we entered that address in the PATH block as shown.

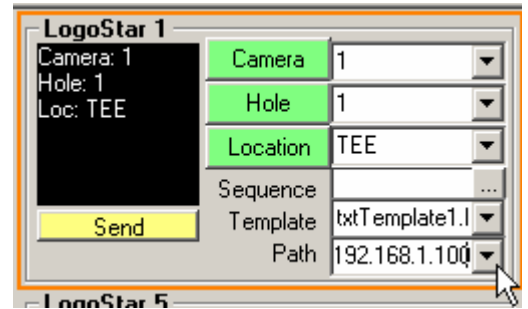

Step 2: Select Sequence

A sequence is a path the text or logo on-screen will follow. For this special Golf Application, Keywest Technology has preset four layouts. You may use any sequence available or create your own (see Sequence Creation starting on Page 17). A simple non-moving logo or text box (as used for this application) would have entrance and exit stages set to 0 seconds and a persistence stage of some value greater than 0 seconds. (See the included examples in the PC controller). To select the sequence you wish to assign to the appropriate cell click the SEQUENCE browse button;

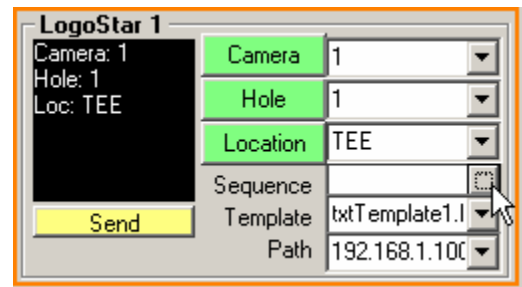

Select the desired sequence from the explorer window by double-clicking.

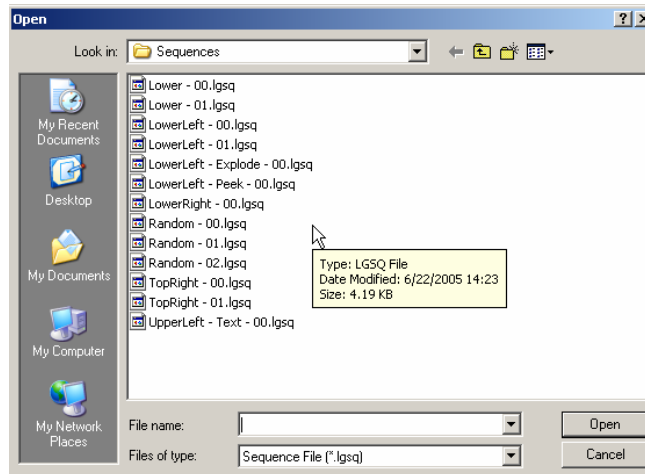

Step 3: Select Template

Template is the text box layout or logo you wish to display on-screen. For this application there are several sample text layouts to choose from. To add one to the selected LogoStar cell or change the currently selected template, simply double-click on any logo or text box shown in LogoStar 300 Logo Clip board.

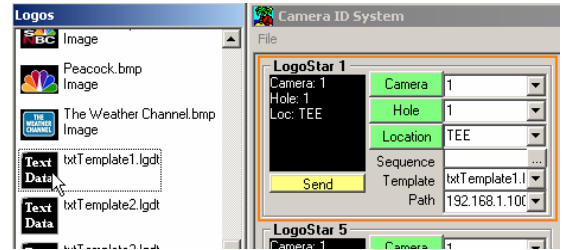

Alternatively, you can use the drop down box to select any logos or text boxes that have previously entered into the Camera ID system.

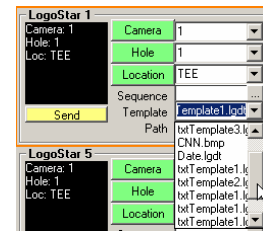

To create new Camera ID text boxes, see Appendix B

Step 4: Set Camera Number, Hole Number, and Location

Finally, choose the assigned Camera Number, Hole Number and Location for the LogoStar under operation (in the GUI, this is referred to as the hot cell). These parameters may be changed by using the drop down arrows and selecting a new value.

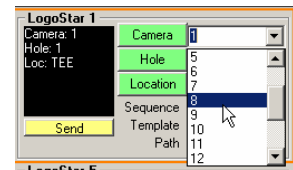

The values may also be changed by clicking on the Green parameter buttons (Camera, Hole, and Location) which will cause the applicable value to toggle to the next available.

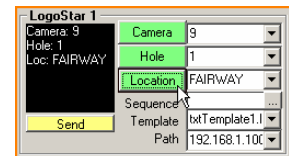

See Appendix B to change the available values for the parameters.

Step 5: Send

Once all your parameters are set and connections are made, the only thing left to do is to send to the LogoStar by clicking the Yellow SEND button. You will receive positive feedback on the GUI if the data was accepted by the LogoStar under operation.

APPENDIX B: Modifying Parameters for Camera ID System

New Camera ID Text Box

First, to create a text block, click on the FILE Menu Item, then TEXT then click NEW.

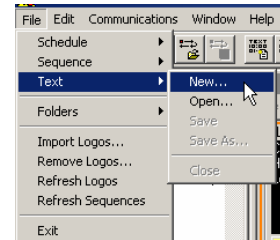

The text editor window will open. This editor window will allow you to create text, edit the fonts and properties, as well as utilized pre-set formats. *Note: You will have to close the Camera ID GUI to access the Text Data Editor GUI.*

Use the FORMAT TEXT box to modify the text display or to create a custom message.

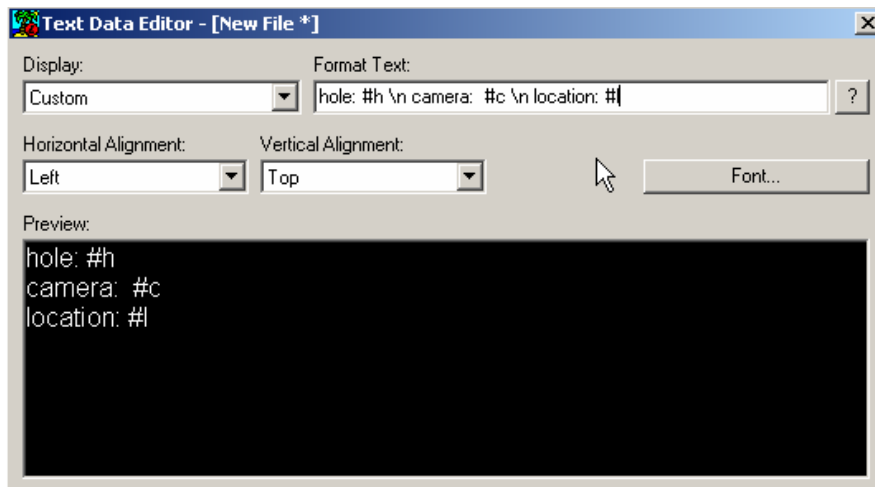

For this application, we use special variables: #h for hole number, #c for camera number, and #l (lower case “L”) for location. When played back, the LogoStar 300 will replace those variable placeholders with actual values from the Location, Hole, and Camera value text files (which are selected in the Camera ID GUI as described previously).

Notice that LINE FEEDS are implemented by the combination character “\n” in the format text box.

The Horizontal and Vertical Alignment boxes and drop-downs set the justification within the editor window only. Positioning on the final display is controlled by the schedule. You simply schedule a text item as you would a logo.

Adjust the parameters of the font in a text item by selecting FONT.

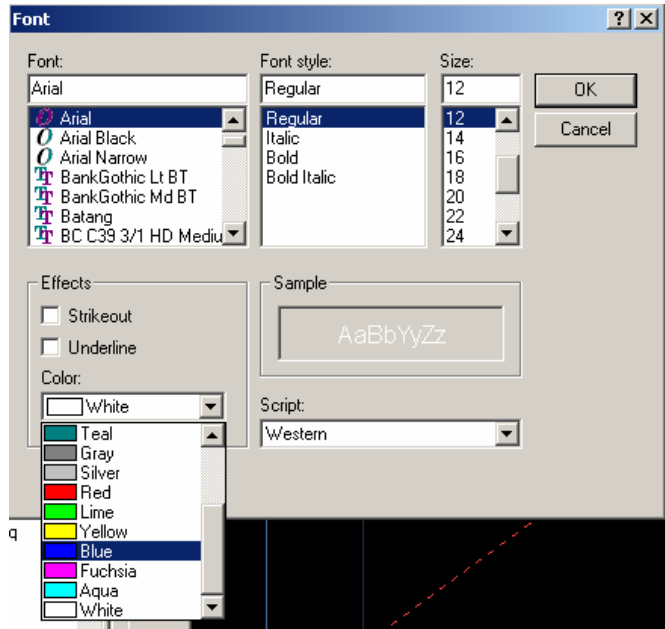

Here, you can change the Font, Style, Size, add Effects as well as set the color of the text to be displayed.

Once complete editing your text item, return to the TEXT Menu item, click SAVE. Your new text item will appear in the Logo Clip Board Window. Double-click from there to add to a Camera ID Cell.

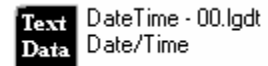

Add, Delete, Modify On-Screen Parameter Values

On the Camera ID GUI, click File and select the parameter you wish to modify.



Use the CUSTOM ENTRIES screen that opens to create new values for holes, cameras and locations as desired. There is no practical limit—you may add, delete, and modify as you see fit.

APPENDIX C: Add-on Programmable Keyboard

The LogoStar 300 Camera ID system is capable of functioning with the XKeys 128-key programmable Keyboard. The current default layout for modes one and two are below.

X-Keys 128 Key Keyboard Camera ID System Layout
Normal Position: Key 2

	I				STICKY 1	CLUB HSE		1 TEE	2 TEE	3 TEE	4 TEE	5 TEE	6 TEE	7 TEE	8 TEE	9 TEE
A					STICKY 2	DRIVE RANGE		1 FWY	2 FWY	3 FWY	4 FWY	5 FWY	6 FWY	7 FWY	8 FWY	9 FWY
B					STICKY 3	INTERVIEW		1 GRN	2 GRN	3 GRN	4 GRN	5 GRN	6 GRN	7 GRN	8 GRN	9 GRN
X					STICKY 4	PUTT GREEN		10 TEE	11 TEE	12 TEE	13 TEE 4	14 TEE	15 TEE	16 TEE	17 TEE	18 TEE
Y					STICKY 5	SPY		10 FWY	11 FWY	12 FWY	13 FWY	14 FWY	15 FWY	16 FWY	17 FWY	18 FWY
Z	W				STICKY 6	POPPY		10 GRN	11 GRN	12 GRN	13 GRN	14 GRN	15 GRN	16 GRN	17 GRN	18 GRN
R	L															
M	JIB 1															
O	JIB 2															SE ND

X-Keys 128 Key Keyboard Camera ID System Layout
 Normal Position: Key 1

Load Form	Sticky 1	Sticky 2	Sticky 3	Sticky 4	Sticky 5	Sticky 6									Escape
Caps Lock	1	2	3	4	5	6	7	8	9	0	- _	+ =			Clear
	Q	W	E	R	T	Y	U	I	O	P	{ [}]	 \ /		
	A	S	D	F	G	H	J	K	L	: ;	" '				
	Z	X	C	V	B	N	M	< ,	> .	? /					
	Space	Space	Space	Space	Space	Space	Space	Space	Space	Space	Space	Space	Space	Space	Exit

Please send in your warranty card or register your LogoStar 300 at ww.keywesttechnology.com

Technical support is available at www.keywesttechnology.com, but you must register the device prior to receiving telephone support. Have your serial number handy when you are registering.

Thank You!

KEYWEST TECHNOLOGY LIMITED WARRANTY

KEYWEST TECHNOLOGY does hereby declare that the said product be covered under limited warranty for defective materials and workmanship. This warranty is extended to the original purchaser only, for the amount of time indicated below, effective from the original purchase date and subject to the following:

******THIS WARRANTY DOES NOT COVER******

- A. Products that have been subjected to abuse, accident, alteration, modification, tampering, negligence, misuse, or if repaired or attempted repair performed by anyone other than a service facility authorized to render such service, or if the model or serial number has been altered, tampered with, defaced, or removed
- B. Operational adjustments covered in this manual

WARRANTY PERIOD: 1 Years Parts & Labor

*REGISTER YOUR PRODUCT AT WWW.KEYWESTTECHNOLOGY.COM or call
1-913-492-4666*

Technical support is not available for unregistered products.